

Operation Manual

MODEL TH2883S8-5/S4-5

Impulse Winding Tester

Tonghui Electronics Co. , Ltd.

**Address : NO. 3, TianShan Road, XinBei
District, Changzhou, Jiangsu, China**

TEL: (0519) 85132222, 85113342

FAX: (0519) 85109972

EMAIL: sales@tonghui.com.cn

Http://www.tonghui.com.cn

Contents

Chapter 1 Overview	1-1
1.1 Production introduction.....	1-2
1.2 Operation environment.....	1-3
1.2.1 Power supply.....	1-3
1.2.2 Environment temperature and humidity	1-3
1.2.3 Warm-up	1-3
1.3 Dimensions and weight	1-3
Chapter 2 General specifications	2-1
2.1 Specifications	2-1
2.2 Comparison methods.....	2-2
2.2.1 Area size comparison	2-2
2.2.2 Differential area comparison.....	2-2
2.2.3 Corona discharge comparison.....	2-3
2.2.4 Differential phase comparison	2-4
Chapter 3 Panels and display	3-1
3.1 Front panel	3-1
3.2 Rear panel.....	3-3
3.3 Introduction to display area.....	3-4
Chapter 4 Introduction to [DISP].....	4-1
4.1 Measurement display page	4-1
4.2 Introduction to symbols in measurement display page	4-1
4.3 Introduction to soft keys in measurement display page	4-1
4.3.1 Display	4-2
4.3.2 Compare.....	4-2
4.3.3 Measure.....	4-3
4.3.4 Utility	4-4
4.3.5 Statistics	4-4
4.3.6 Modify	4-5
Chapter 5 Introduction to [SETUP]	5-1
5.1 Introduction to icons of soft keys	5-1
5.2 Measurement setup page	5-1
5.2.1 Step	5-2
5.2.2 Mode.....	5-2
5.2.3 CH1-CH8(TH2883S8-5), CH1-CH4(TH2883S4-5) Channel setup	5-3
5.2.4 Samp- can be set in TEST mode	5-3

5.2.5 Test Imp-	can be set in TEST mode	5-3
5.2.6 Erase Imp-	can be set in TEST mode	5-3
5.2.7 Volt ADJ-	can be set in TEST mode	5-4
5.2.8 Start Volt-	can be set in BDV test mode	5-4
5.2.9 End Volt-	can be set in BDV test mode	5-4
5.2.10 Volt Step-	can be set in BDV test mode	5-4
5.2.11 Comparator		5-5
5.2.12 Position (AREA SIZE, DIFF ZONE, PHASE DIFF)		5-5
5.2.13 Position (PHASE DIFF)		5-5
5.2.14 DIFF (Limit) (AREA SIZE, DIFF ZONE, PHASE DIFF)		5-6
5.2.15 DIFF (Limit) (CORONA)		5-6
5.3 Match Setup		5-6
5.3.1 Step		5-7
5.3.2 Mode		5-8
5.3.3 Std.Name-	available in Sample mode	5-9
5.3.4 Step NO.-	available in SW.Copy	5-9
5.4 Int. File		5-9
5.5 Ext. File		5-11
Chapter 6 Introduction to [SYSTEM]		6-1
6.1 System		6-1
6.1.1 Brightness		6-2
6.1.2 Pass/Fail		6-2
6.1.3 Pass Alarm		6-2
6.1.4 Fail Alarm		6-2
6.1.5 Key Sound		6-2
6.1.6 Hard Copy		6-2
6.1.7 Password		6-3
6.1.8 Language		6-3
6.1.9 Theme		6-3
6.1.10 Date		6-3
6.1.11 Time		6-4
6.2 Parameter		6-4
6.2.1 Wave Disp		6-5
6.2.2 Trig Mode		6-5
6.2.3 Delay Time		6-6
6.3 Interface		6-6
6.3.1 I/O		6-7
6.3.2 TH2883 RS232C interface		6-7
6.3.3 USB interface		6-9

6.3.4 LAN interface	6-11
6.4 About	6-13
Chapter 7 User guide	7-1
7.1 Use of keys	7-1
7.1.1 Use of the roller	7-1
7.1.2 Switch the display page	7-1
7.1.3 Numeric arrow key	7-1
7.2 Basic measurement.....	7-2
7.2.1 Non-standard test	7-2
7.2.2 Sample test for standard wave	7-2
7.3 BDV test.....	7-2
7.4 Technology application	7-3
7.4.1 Test objects.....	7-3
7.4.2 Select comparison method	7-3
7.4.3 Settings of comparison method.....	7-4
7.4.4 Select standards.....	7-4
7.4.5 Chart for differential area.....	7-4
Chapter 8 Command reference	8-1
8.1 Command structure	8-1
8.2 Notation conventions and definitions.....	8-3
8.3 Command reference	8-3
8.3.1 DISPlay subsystem commands	8-3
8.3.2 IVOLTage subsystem commands.....	8-6
8.3.3 SRATE subsystem commands	8-9
8.3.4 COMParator subsystem commands	8-10
8.3.5 TRIGger subsystem commands	8-16
8.3.6 STATistic subsystem commands.....	8-17
8.3.7 WADJust subsystem commands	8-18
8.3.8 SWAVE subsystem commands	8-18
8.3.9 FETCh? subsystem commands	8-20
8.3.10 MEASure subsystem commands	8-22
8.3.11 ABORt subsystem command	8-24
8.3.12 Mass MEMory subsystem commands	8-24
8.3.13 MeasSTEP subsystem commands.....	8-25
8.3.14 WaveSTEP subsystem commands.....	8-27
8.3.15 Common commands	8-28
8.4 Error and warning message	8-29
Chapter 9 Handler interface.....	9-2

9.1 Basic information	9-2
9.2 Electrical characteristics.....	9-3
9.2.1 DC isolated output	9-3
9.2.2 Isolated input.....	9-4
9.3 Jumper setup on HANDLER interface.....	9-5
Chapter 10 Package contents and warranty	10-1
10.1 Package contents	10-1
10.2 Warranty.....	10-1

Chapter 1 Overview

Thank you for your use of our products. Before the use of it, please locate the items listed in this manual to ensure nothing is missing. If in the case that any item is missing, please contact us immediately.

It is necessary to read this manual carefully before your proper use of TH2883S series impulse winding tester.

Warning!

1) Operation

Do not put heavy objects on the tester.

There is a cooling fan on the rear side of this instrument, so any block of the air inlet is prohibited.

2) Rigid power input

The stability of high voltage depends on stable power input. Be sure to provide rated AC power or corrected power.

3) Grounding

For the safety of personnel and instrument, ensure the grounding terminal, designed in power cord, be grounded correctly.

4) Test cable

To avoid electrical shock hazard, do not touch test terminals and test samples. The reason is that a high voltage test cable is connected to the rear panel of this instrument, thus when testing, the cable and test samples connected will carry a high voltage.

5) DO NOT open case unauthorized!

To avoid the injury to personnel and damage to the instrument, do not open the case unauthorized due to the existence of high voltage in instrument.

6) Carry or move

Before moving the instrument, unplug the AC power sockets and remove high voltage test line or external control line.

7) Maintenance

In non-use state, the instrument should be covered with a plastic or cloth cover. To clean the tester, wipe the dirty parts with a soft cloth soaked with diluted neutral detergent. Do not use the following chemicals to clean the instrument: diluent, benzene or organic solvent with similar chemical property with above materials.

8) Location

Do not locate the instrument in the environment of high temperature, direct sunlight or

poor ventilation. In addition, the instrument will generate high voltage, so it must be used at room temperature and in the absence of much dust.

1.1 Production introduction

Due to the influence of wire material, magnetic material, framework and manufacture technics, winding products such as transformers, motor windings may have defects of low insulation between winding layers, circles and leads. TH2883S series impulse winding tester, adopting high-speed sampling techniques, is a new test instrument for insulation performance of winding products.

TH2883S series compares the standard waveform stored in the non-volatile memory with the current tested waveform. TH2883S series provides the PASS or FAIL comparison result according to AREA SIZE, DIFFERENTIAL AREA, CORONA DISCHARGE or DIFFERENTIAL PHASE. With its strong functions, accurate comparison methods, easy operation and various interfaces, TH2883 can provide a perfect test solution for most winding products.

Principles of impulse winding test

The impulse winding tester tests the electrical characteristics of coil winding without damaging the DUT. The prerequisite condition is to test the quality of a coil at just a glance. The detection is carried out when the same electric impulse, as used in the standard coil and here discharged by a capacitor, is applied to the DUT. The voltage attenuation wave is generated in response to the impulse, related to the Q-factor and inductance of the coil. In this sense, the tester can detect turn and layer short, the differences in the number of turns and the material of the core. If high impulse voltage is applied, the poor insulation will appear as a corona or layer discharge.

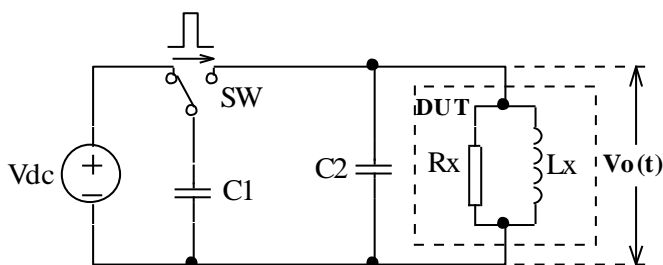

Figure 1-1 Simplified diagram for principles of impulse winding test

In figure 1-2, the self-oscillation attenuation wave has a close relation with the inductance L and quality factor Q , while L and Q depend on the number of turn, manufacture technology, properties of iron core material and whether it has air-coils. What's more, the applied voltage is a high impulse voltage, thus, it is easy to observe the short circuit, partial short turns and lays or turns discharge phenomenon caused by insulation damage.

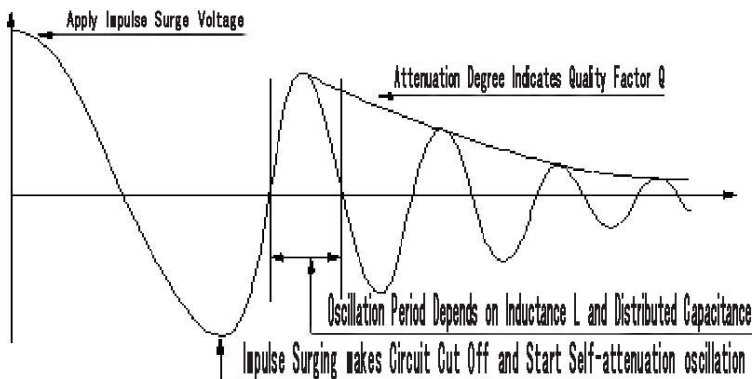

Figure 1-2 Typical self-attenuation oscillation wave

1.2 Operation environment

1.2.1 Power supply

Voltage: 198V-242V AC, 99V-121V AC

Power frequency: 47.5Hz-63Hz

Consumption: $\leq 200\text{VA}$

1.2.2 Environment temperature and humidity

Normal working temperature: $0^{\circ}\text{C} \sim 40^{\circ}\text{C}$, Humidity: $\leq 90\% \text{RH}$

Referential working temperature: $20^{\circ}\text{C} \pm 8^{\circ}\text{C}$, Humidity: $\leq 80\% \text{RH}$

Transferring environment temperature: $0^{\circ}\text{C} \sim 50^{\circ}\text{C}$, Humidity: $\leq 93\% \text{RH}$

1.2.3 Warm-up

The warm-up time should not be less than 15 minutes.

1.3 Dimensions and weight

Dimensions (W*H*D): 400mm×132mm×420mm

Weight: Approx. 15.0kg

Chapter 2 General specifications

2.1 Specifications

Specifications	TH2883-1	TH2883-5	TH2883-10	TH2883S8-5	TH2883S4-5
Impulse voltage	30V-1200V 5V steps ±5% ±5V	100V~5000 V 10V steps 5% ±15V	500V-10kV 20V steps ±5% ±25V	100V-5000V 10V steps ±5% ±15V	100V-5000V 10V steps ±5% ±15V
Number of channels	1	1	1	8	4
Inductance test range	≥1uH	≥10uH	≥20uH	≥10uH	≥10uH
Impulse energy	Max 0.02J	Max 0.25 J	Max 0.5J	Max 0.25J	Max 0.25J
Test speed	6 times/sec	6 times/sec	3 times/sec (voltage output = 10kV)	6 times/sec (single channel)	6 times/sec (single channel)
Pulses applied	Max. 32				
Input impedance	5MΩ				
Display	800×480 dot-matrix LCD, 65k color TFT; Waveform display dots: 600x256				
Waveform acquisition	8 adjustable sampling rate: Max.200Msps Resolution: 8 Bits Memory depth: 6k Bytes Average: 1-32				
Comparison method	Compared with standard waveform: AreaSize Comparison DiffZone Comparison Corona Comparison PhaseDiff Comparison				
Waveform measurement	Voltage, time and frequency				
Trigger mode	Manual (Foot), External, Bus, Internal,				
Detection output	OK/Ng display, LEDdisplay, Beeper alarm				
Measurement statistics	Statistics for measurement results				
Memory	Built-in memory: 20 standars waveforms and settings				

	USB disk : external memory	
Interface	Handler,RS232C,USB Device,USB Host,Lan	
Power		
Power supply	110V/220V $\pm 10\%$ 50Hz/60Hz $\pm 5\%$	
Power consumption	$\leq 200\text{VA}$	
General specifications		
Working environment	Temperature	0°C - 40°C
	Humidity	$\leq 75\%$ R.H.
Safety and compatibility	electromagnetic IEC61010-1: 2001, IEC61326-2-1: 2005	

2.2 Comparison methods

2.2.1 Area size comparison

As shown in figure 2-1, when comparison method is set to AREA SIZE, the area sizes of both standard waveform and the tested waveform are calculated (integration method) between A and B. The percent deviation is the ratio of the area size difference to the area size of the standard waveform between A and B, expressed as a percentage.

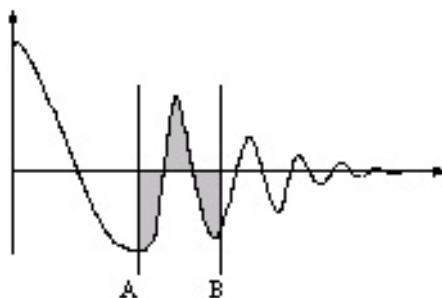

Figure 2-1 Area Size Comparison

The area size of the waveform is nearly proportional to the energy loss in the winding. When a sample winding has a short circuit between layers, the short circuit area is reflected as an increase of energy loss.

2.2.2 Differential area comparison

When comparison method is set to Differential Area, TH2883 calculates the area size of differential portion between the standard waveform and the tested waveform from A to B. (The differential portion area size is indicated as the shaded part in Figure 2-2.) The percent deviation

is the ratio of the differential portion area size to the area size of the standard waveform between A and B, expressed as a percentage.

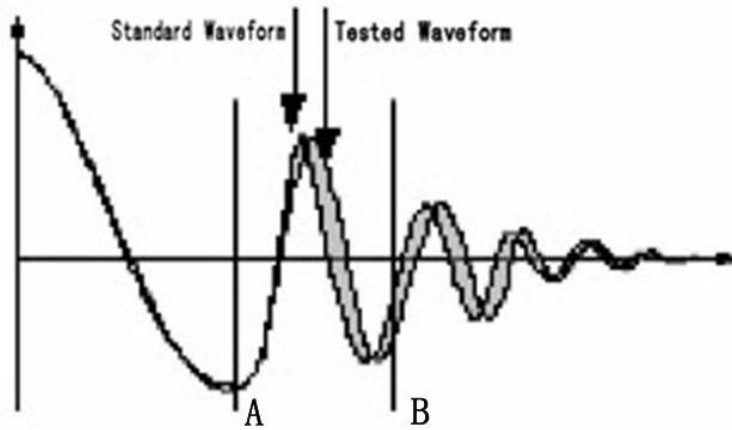

Figure 2-2 Differential Area Comparison

The differential area size reflects the value of inductance and total energy loss. This method is especially effective to detect the differences of inductance L between the standard winding and the tested winding.

2.2.3 Corona discharge comparison

When comparison method is set to Corona Discharge, TH2883 detects the high frequency energy of corona discharge from A to B as shown in Figure 2-3. When the corona evaluation value is less than the corona difference limit, then the comparison result will be PASS. When the corona evaluation value is more than the corona difference limit, then the comparison result will be FAIL. The corona evaluation value and difference limit are both expressed as an integer.

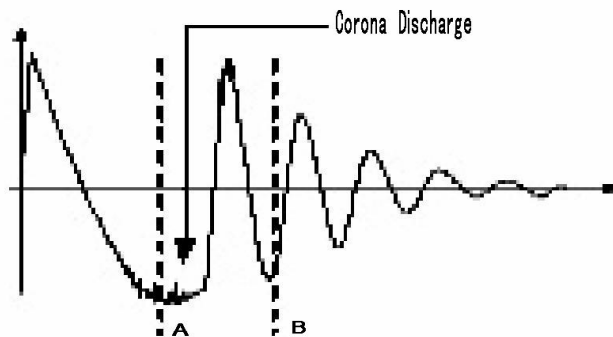

Figure 2-3 Corona Discharge Comparison

User can sample some coil samples (e.g. 10 samples) to set an effective corona discharge value. First, applying an impulse voltage to each coil will gain the corona discharge value of each coil.

Then, a new effective value can be set by adding 20% to the maximum corona discharge value. In order to ensure the correctness of the new value, user can test these coils once more and observe the corona PASS or FAIL.

2.2.4 Differential phase comparison

User can specify a zero-crossing point to compare. The instrument will judge the zero-crossing offset between the tested waveform and standard waveform and then compare the oscillation period between the two waveforms. The percentage of the two values will be taken as the judging criterion and the reference is set by percentage. As is shown in figure 2-4, A~B is the offset and C~D is the oscillation period of standard waveform. The third zero-crossing point of the compared waveform is to set.

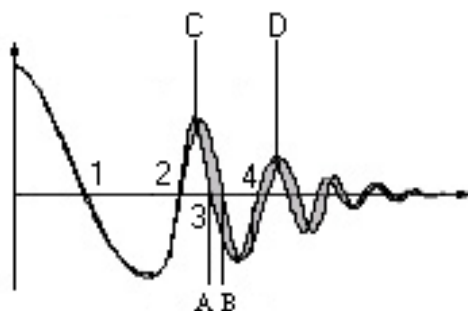
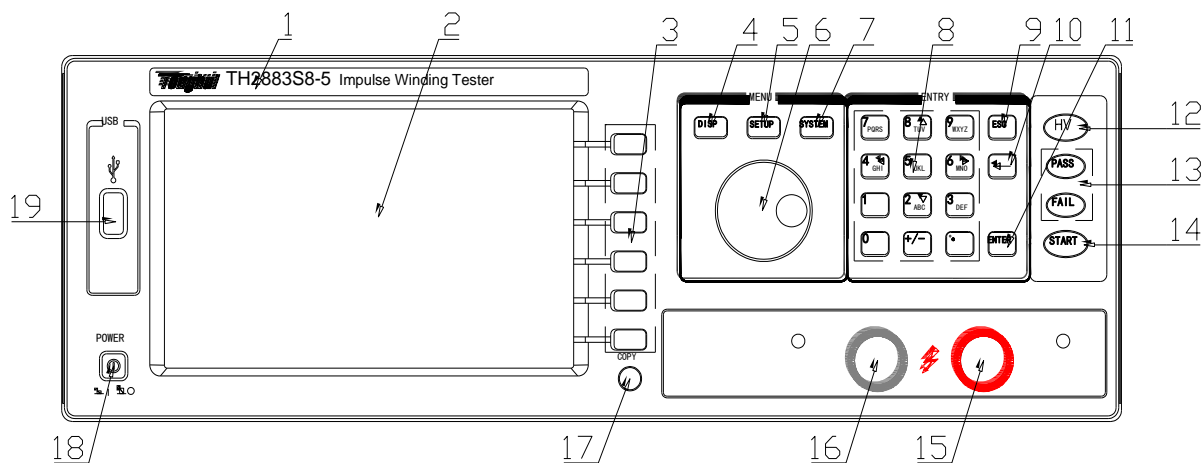

Figure 2-4 Phase Differential Comparison

NOTE: The tester can only set zero-crossing points from 2 to 10. The first zero-crossing point cannot reflect the actual performance of coils, so it is not necessary to set the first point. In real phase differential comparison, there are four results generated: PASS, FAIL, FAIL1 and FAIL2. PASS is up to standard; FAIL, below standard. While FAIL1 means the zero-crossing point has not been found, that is to say, it is unable to find the set zero-crossing point on the waveform of the tested coil; FAIL2 indicates that a complete period cannot be found on the standard waveform. As shown in figure2-4, the third zero-crossing point must be present in the waveform so as to ensure the normal operation of phase differential comparison.

Chapter 3 Panels and display

3.1 Front panel



<i>Serial Number</i>	<i>Name</i>	<i>Instruction</i>
1	Brand and model	
2	LCD	320×240 Large-Scale dot-matrix LCD displays measurement waveform, set parameters, system configurations, etc.
3	SOFTKEY	The five keys' functions are not fixed and have different functions in different menus. Five soft keys are used to select control and parameter functions. Current function of each soft key is displayed along its left side.
4	[DISP]	Press [DISP] menu key to enter the <MEAS DISP> page.
5	[SETUP]	Press [SETUP] menu key to enter the <MEAS SETUP> page.
6	Roller	Control the movement of the cursor, confirm and modify data
7	[SYSTEM]	Press [SYSTEM] menu key to enter the <SYSTEM SETUP> page.
8	NUMBER keys	Input numbers or characters
9	ESC	[ESC] key is used to cancel the enter of numbers or

		characters.
10	BACKSPACE	The function of BACKSPACE key is to delete numbers or characters wrongly entered.
11	ENTER	ENTER key terminates numeric input data and enters the displayed value on the data input line (bottom line of the LCD screen).
12	HV	High Voltage Indicator indicates that the instrument is outputting dangerous impulse test voltage to the HV terminal on the rear panel. Do not touch test terminals or DUT.
13	PASS/FAIL indicator	When PASS indicator flashes, the comparison result is up to standard; while FAIL, below indicator. Valid only in comparison function.
14	START	Press the START key to start a measurement. In the process of test, pressing the key will terminate the measurement.
15	High voltage terminal	Output high voltage. Although all 8 channels (TH2883S4-5 is equipped with 4 channels) are not equipped with it, this high voltage terminal has high voltage output when pressing START.
16	Ground terminal	Low terminal for high voltage test, connecting to a test fixture and DUT with 15.
17	COPY	Capture the screen information
18	POWER	Switch on or off the main power
19	USB Host interface	An USB disk can be connected for standard waveforms and measurement conditions storage.

Table 3-1 Front panel instruction

3.2 Rear panel

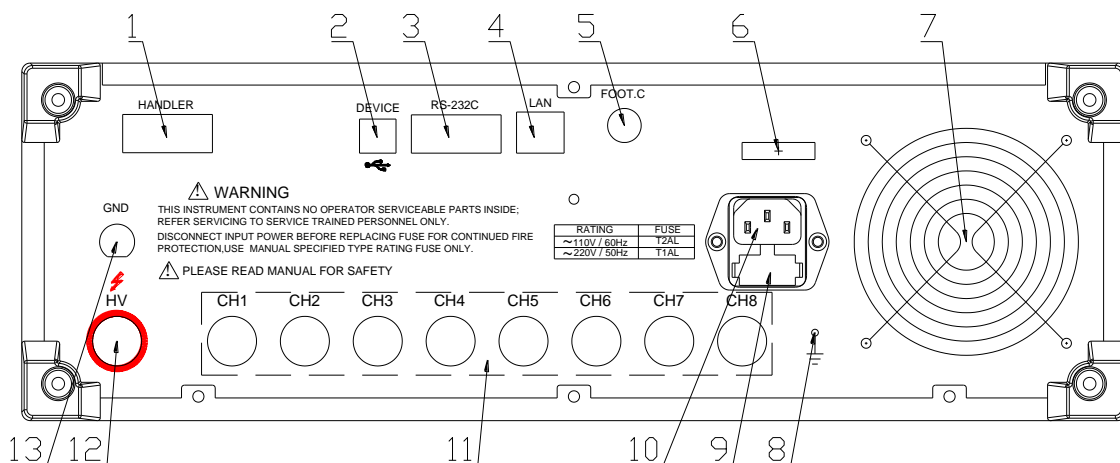

<i>Serial number</i>	<i>Name</i>	<i>Instruction</i>
1	HANDLER interface	Comparison results are output via the handler interface. You can also start or stop a test through the interface.
2	USB DEVICE interface	A PC can remotely control TH2883 through the USB DEVICE interface.
3	RS232C serial interface	RS232C serial interface can be connected to an external device for remote control and operation
4	LAN interface	Be used to connect network cable.
5	FOOT CONTROL	A footswitch can be used to start a measurement instead of pressing the START key from the front panel.
6	Name plate	Show manufacture date, model, batch number, manufacturer, etc.
7	Fan window	Discharge heat.
8	Ground terminal	Ground the instrument shell.
9	Fuse	Fuse is used to protect the instrument .220V/1A
10	3-wire power socket	Connect the power.
11	Scanning Test Terminal	TH2883S8-5 has 8 scanning test terminals, from CH1 to CH8 TH2883S4-5 has 4 scanning test terminals, from CH1 to CH4
12	Test terminal	High voltage output terminal, the function is the same as that of the high voltage terminal 15 on the

		front panel.
13	Test terminal	It is the GND terminal connected to the DUT with 11 and 16 on the front panel.

Table 3-2 Rear Panel Instruction

3.3 Introduction to display area

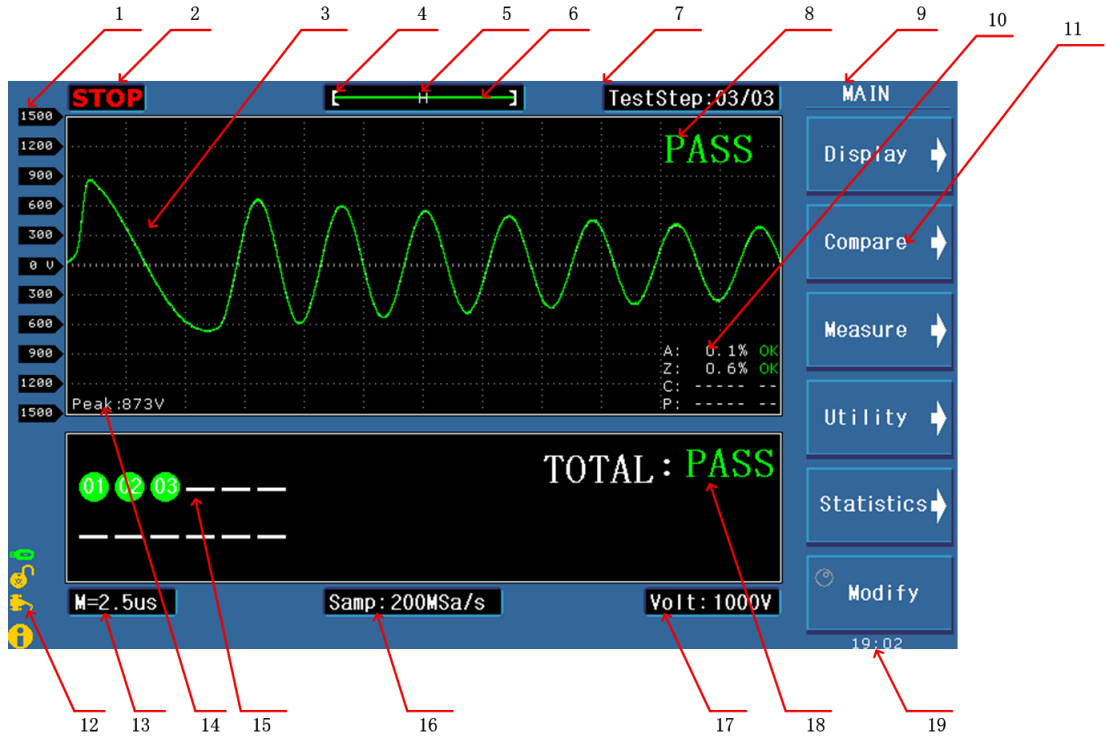

Specific definition for each area:

- 1 Voltage
Show the voltage of waveform
- 2 Test status
RUN means in the test process, STOP means the test has been terminated.
- 3 Waveform display area
In this area, test and standard waveforms, peaks of impulse voltage and comparison results are displayed.
- 4 Indicate the waveform location in the memory.
- 5 Indicate whether a standard waveform exists. N means a standard waveform exists while H does not.
- 6 Show the memory depth and indicate the current display color of the test waveform. User can use the roller to change the color.
- 7 Test step

Display format: XX/XX. The first two digits display the step number of the current waveform display and comparison and the latter two digits display the total numbers of steps. The maximum steps can be set is 20.

- 8 Measurement result
Show the final measurement result.
- 9 Comparison result
Four comparison results and their final display results.
- 10 Main menu for soft key
- 11 Function zones of soft keys
Show the corresponding function and parameter of each soft key.
- 12 Information
Show the state of interface selecting, availability of U disk, key lock, etc.
- 13 Time base
This area shows the time between the two dash lines of this waveform display area in X direction. The time shown in this area cannot be modified by user but varies with the sampling rate and time base zoom.
- 14 Peak value
Show the peak value of the current test voltage.
- 15 Comparison results for several steps
This area displays the comparison results for several steps. The number displays the set step number. When the display is set as SINGLE DISPLAY, this area displays the corona of the selected step.
- 16 Sampling rate
Show the sampling rate of the current waveform, which can be altered by the [Modify] soft key and the roller.
- 17 Impulse voltage
Show the current set impulse voltage.
- 18 Final measurement result
Show the final measurement result. When the measurement results of all steps are PASS, the final measurement result displays PASS, or else displays FAIL. When the display is set as SINGLE DISPLAY, there is no display in this area.
- 19 Time
Display the real time.

Chapter 4 Introduction to [DISP]

Press the DISP menu key to enter the < MEAS DISP> page (the default page). In this page, measurements are taken and the test waveform is displayed. Some function settings such as standard sampling (Standard), comparison setting (Compare), measurement function (Measure), auxiliary function (Utility), statistic function (Statistics), display color of the waveform, test step, sampling rate, etc. Figure 4-1 shows the measurement display page.

4.1 Measurement display page

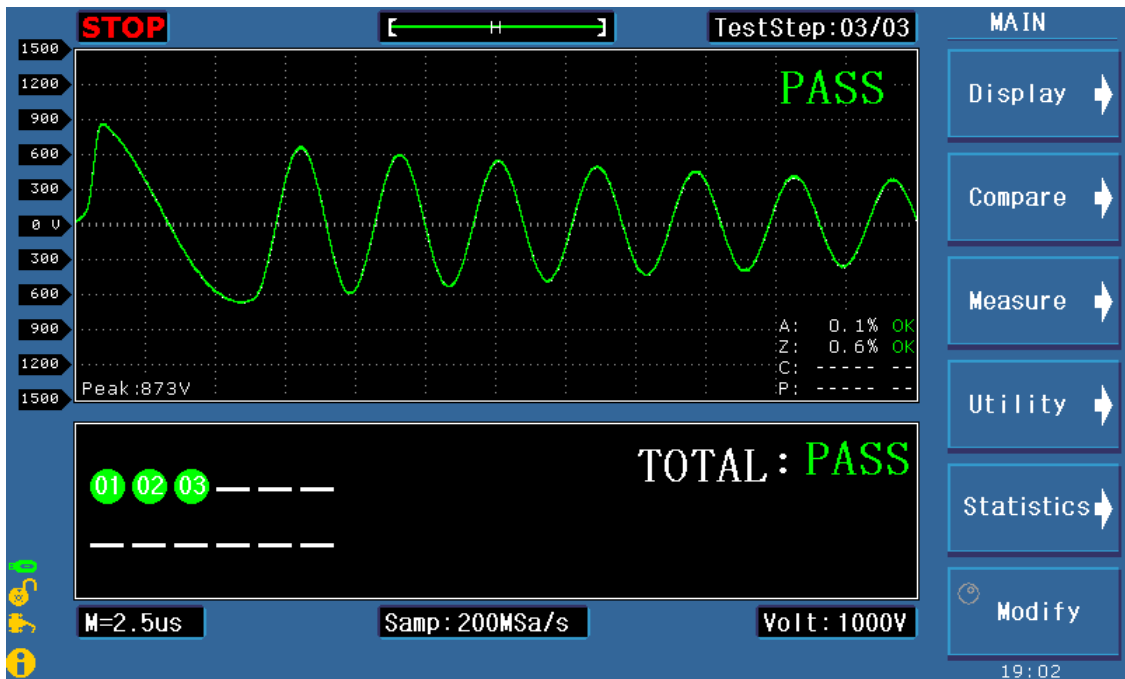

Figure 4-1 Measurement display page

4.2 Introduction to symbols in measurement display page

- ✧ Enter the next menu.
- ✧ Return to the upper menu.
- ✧ Lighten this symbol to enable the roller, while darkening this symbol to disable the roller. The roller can be rotated and has the function of a key.

4.3 Introduction to soft keys in measurement display page

- ✧ **Display** Enter the **Display setup** sub-menu. Under this menu, multi and single display can be selected.

- ✧ **Compare** Enter the **Compare setup** submenu. Under this menu, states of the four compare methods, compare parameters can be set.
- ✧ **Measure** Enter the **Compare function** submenu. Under this menu, wave voltage, wave time, wave frequency can be set.
- ✧ **Utility** Enter the **Utility function** submenu. Under this menu, internal file, wave amplitude, grid in the waveform display zone, corona display zone, and the state of the key lock can be set.
- ✧ **Statistics** Enter the **Statistics function** submenu. Under this menu, statistics for the current test result can be set. User can select to open, clear or save data.
- ✧ **Modify** Press the corresponding soft key and revolve the roller to modify the impulse voltage, sampling rate, etc.

4.3.1 Display

The instrument provides two display mode: multi and single.

4.3.1.1 Multi

- If Multi is selected, all the test results of the inserted test steps will be displayed on the screen below. When all the results of the test steps are OK, the final result is PASS. Once one of the test step fails, the final result is FAIL.

4.3.1.2 Single

- If Single is selected, the current test result of the selected test step will be displayed on the screen below, including the comparison result, corona and peak voltage.

4.3.2 Compare





TH2883 series provides four kinds of compare methods as follows: Area Size Comparison, Differential Area Comparison, Corona Discharge Comparison and Phase Differential Comparison. The instrument collects the waveform data of 6000 points, thus user can select the comparison area between the start position and 6000.

Press the **Compare** soft key to enter the main menu of it. Four compare methods can be set under this menu.

Note: Press the **Position 0000-6000** soft key to enable the roller. When the roller is revolved, two parallel yellow lines (except Differential Phase comparison) will be displayed in the waveform display zone. The full line is the selected one, while the dash line is not the selected one.

4.3.2.1 AREA SIZE

- ✧ **Method AREA** Select the area comparison method.

- ◇  State means this method is turned on, while means off.
- ◇  Position 0000-6000 Lighten this icon to enable the roller. The start point, the end point or both the start and the end points will be selected by the press of the roller. Revolve the roller will change the position of the start point, the end point or both the start and the end points by 10 points. The position ranges from 0 to 6000.
- ◇  Diff 2.0% Lighten the icon to enable the roller and change the differential value.
- ◇  Return to previous page.

4.3.2.2 DIFF ZONE

Method
DIFF ZONE

Select the differential area size comparison method. All setup operations are the same as those of AREA SIZE.

4.3.2.3 CORONA

Method
Corona

Select the corona comparison method. All setup operations are the same as those of AREA SIZE. The corona comparison value has no unit ranging from 1 to 255.

4.3.2.4 PHASE DIFF

Method
PHASE DIFF



Select the phase differential comparison method. All setup operations are the same as those of AREA SIZE. But the position parameter is different, it means to choose the zero-crossing position and the value ranges from 2 to 99.

4.3.2.5 Return to the main menu.

4.3.3 Measure

Measurement function is used to measure impulse voltage, time and frequency.

Note: When a function is selected and the roller is enabled, two lines will be displayed in the waveform display zone. The differential value of the two lines corresponds to the value showing on the second soft key.

- ◇  Voltage 1000V Press the roller to switch between the high limit, the low limit and the high and low limits. Then revolve the roller to change the position of the high and the low limits. The voltage differential value between the high and the low limits (ΔV) is as shown on the second soft key.
① Note: The default low limit locates on the center line.
- ◇  Time 10.00μ s The high limit, the low limit or the high and the low limits can be

selected by the press of the roller. Then revolve the roller to change the position of the high and the low limits. The differential value between the high and the low limits (Δs) is as shown on the second soft key.



















The high limit, the low limit or the high and the low limits can be selected by the press of the roller. Then revolve the roller to change the position of the high and the low limits. The differential value between the high and the low limits (ΔHz) is as shown on the second soft key.



Return to the main menu.

4.3.4 Utility

Utility function is used to set waveform files and parameters displayed in the waveform display zone.

- ◇   Press this soft key, the internal file system page will pop up and the soft key zone will display soft keys under **File Menu**. See 5.3 *Operation for internal file system* for details.
- ◇   Lighten the icon and enable the roller. Then revolve the roller to enlarge the waveform display scale ranging from 1 to 3 times. When the display scale is larger than 1 times, the ratio will be displayed in the top right corner of the waveform display zone.
- ◇   means the grid is turned on, while is off.
- ◇   means the corona is turned on. The secondary display zone will display the quantity of the extracted corona.
 means the corona is turned off. The secondary display zone will display basic test parameters of the standard waveform and the comparison methods.
- ◇    This soft key is used to lock the keyboard. When the function is enabled, the icon  will be displayed in the information zone. This soft key is also the **Unlock** key.
- ◇   This soft key is used to unlock the keyboard. Its icon is .
- ◇   Return to the **main menu**.

4.3.5 Statistics

Check, save or clear statistic results.

Press **Statistics**, the statistics page will pop up. This page shows each method's measure times, pass times and ratio of pass.

- ◇ **State** means this function is turned on, while is off.

-
- ✧ Clear Clear the current statistic results.
 - ✧ Save Save the current statistic data to external U disk. The default format is csv.
 - ✧  Return to the **main menu**.

4.3.6 Modify

See 4.3.1.4.





Chapter 5 Introduction to [SETUP]

Press **[SETUP]** to enter the <Meas Setup> page. This is a toggle key, by pressing it, the displayed page can be toggled among <Meas. Setup>, <Match Setup>, <Int. File> and <Ext. File>.

5.1 Introduction to icons of soft keys

- ◇  Numerical arrow key. Lighten this icon to enable this key. Respectively press the four keys, 8, 2, 4, 6, the cursor will move up, down, left and right. When the icon becomes dark, the numerical arrow key is disabled. Likewise the cursor can be moved by pressing **[START]** (except in the measure display page).

NOTE: When the icon is lightened, the original numerical input function for the four numerical keys will be invalid.

- ◇  Coarse adjustment key used to increase the selected value.
- ◇  Coarse adjustment key used to decrease the selected value.
- ◇  Fine adjustment key used to increase the selected value.
- ◇  Fine adjustment key used to decrease the selected value.

5.2 Measurement setup page

Figure 5-1 shows the measure setup page.

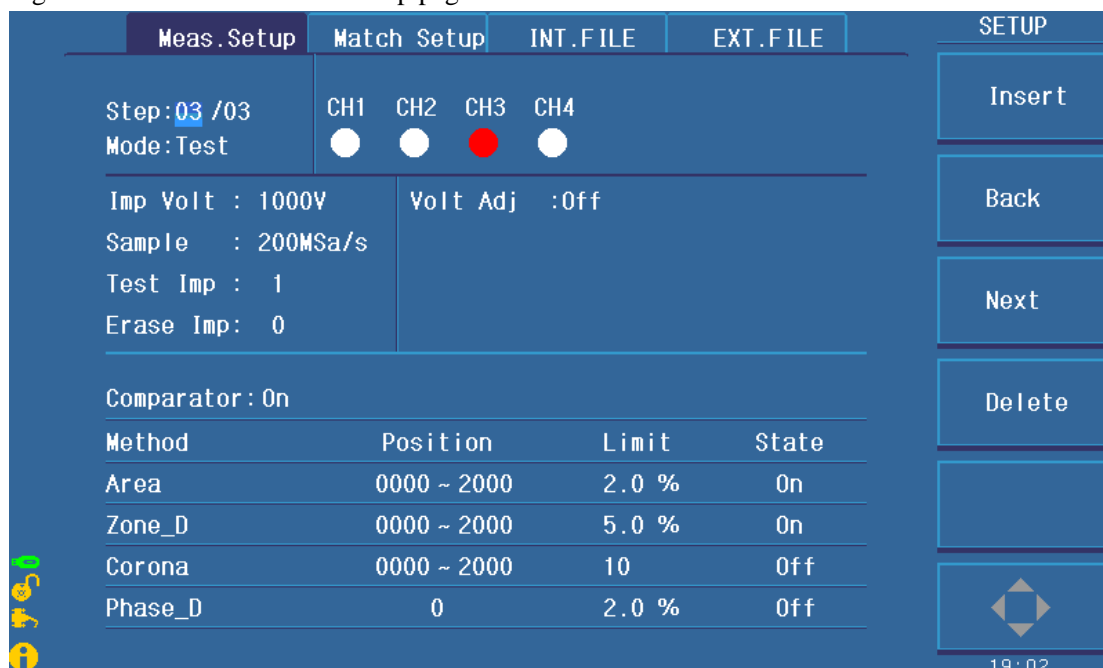

Figure 5-1 Measure setup page

Follow parameters can be set in <Setup>.

- ✧ Step (**Step**)
- ✧ Mode (**Mode**)
- ✧ CH1-CH8(TH2883S8-5), CH1-CH4(TH2883S4-5) Channel Setup
- ✧ Impulse voltage (**Imp Volt**)
- ✧ Sampling rate (**Samp**)
- ✧ Test impulse (**Test Imp**)
- ✧ Erase impulse (**Erase Imp**)
- ✧ Voltage adjustment (**Volt ADJ**)
- ✧ Start voltage under Breakdown voltage test (**Start Volt**)
- ✧ End voltage under Breakdown voltage test (**End Volt**)
- ✧ Voltage step under Breakdown voltage test (**Volt Step**)
- ✧ Comparator (**Comparator**)
- ✧ Position (**Position**)
- ✧ Limit (**Limit**)
- ✧ State (**State**)

5.2.1 Step

The impulse voltage is between 100V~5000V and the minimum step is 10V. Move the cursor to Imp Volt zone, following soft keys will be displayed.

- ✧ **Insert** Insert a test step.
- ✧ **Back** Select the last test step.
- ✧ **Next** Select the next test step.
- ✧ **Delete** Delete the current test step.

- ✧  Lighten this key to enable the numerical arrow key. Respectively press 8, 2, 4, 6, the cursor will move up, down, left and right.

5.2.2 Mode

The impulse voltage is between 100V~5000V and the minimum step is 10V. Move the cursor to Imp Volt zone, following soft keys will be displayed.

- ✧ **Test** Select the test mode. The setup of the following five control parameters will be displayed: Imp Volt, Samp, Test Imp, Erase Imp and Volt ADJ.
- ✧ **BDV** Select the BDV test. BDV test is a test method for turn-to-turn insulation test. Starting from Start Volt and ending at End Volt by a resolution of Volt Step, the test is finally done by comparing with four comparison methods. The setup of the following four control parameters will be displayed: Start Volt, End Volt, Step and Samp.
- ✧  Lighten this key to enable the numerical arrow key. Respectively press 8, 2, 4, 6,

the cursor will move up, down, left and right.



5.2.3 CH1-CH8(TH2883S8-5), CH1-CH4(TH2883S4-5) Channel setup

TH2883S8-5 provides 8 channels from CH1 to CH8, TH2883S4-5 provides 4 channels from CH1 to CH4. Move the cursor to the corresponding channel, CLOSE, HIGH and LOW can be set for this channel. Red means the current mode of the channel is HIGH. Black means the current mode of the channel is LOW. White means the current mode of the channel is CLOSE.

- ✧ CLOSE Close this test channel.
- ✧ HIGH Set the mode of this channel as HIGH.
- ✧ LOW Set the mode of this channel as LOW.
- ✧  Lighten this key to enable the numerical arrow key. Respectively press 8, 2, 4, 6, the cursor will move up, down, left and right.



5.2.4 Samp- can be set in TEST mode

200MSa/s, 100MSa/s, 50MSa/s, 25MSa/s, 12.5MSa/s, 6.25MSa/s, 3.12MSa/s, 1.56MSa/s are optional for sample rate. Move the cursor to the sample rate zone, following soft keys are available.

- ✧   Be used to select the desired sample rate.
- ✧  Lighten this key to enable the numerical arrow key. Respectively press 8, 2, 4, 6, the cursor will move up, down, left and right.



5.2.5 Test Imp- can be set in TEST mode

The number of tested impulses can be set from 1 to 32. Move the cursor to this zone, the following soft keys will be displayed.

- ✧   They are fine adjustment soft keys used to change the number of impulses by 1.
- ✧  Lighten this key to enable the numerical arrow key. Respectively press 8, 2, 4, 6, the cursor will move up, down, left and right.
- ✧ **Note: User can directly input the desired number by numerical keys. In the state of inputting numbers, soft keys are unavailable. ENTER can be used to terminate inputting.**

5.2.6 Erase Imp- can be set in TEST mode

The number of erase impulses can be set from 0 to 16. Move the cursor to this zone, following soft keys will be displayed.

- ◇   They are fine adjustment soft keys used to change the number of impulses by 1.
 - ◇  Lighten this key to enable the numerical arrow key. Respectively press 8, 2, 4, 6, the cursor will move up, down, left and right.
- ☛ **Note: User can directly input the desired number by numerical keys. In the state of inputting numbers, soft keys are unavailable. ENTER can be used to terminate inputting.**

5.2.7 Volt ADJ- can be set in TEST mode





For different load on each DUT, when a given impulse voltage is applied across them, the actual voltage applied on each DUT may also be different. User can turn on the voltage adjust function to automatically change the output voltage, thus making all voltages applied across all DUT identical.

Move the cursor to this zone, following soft keys will be available.

- ◇ **ON** Turn on the voltage adjust function.
- ◇ **OFF** Turn off the voltage adjust function.
- ◇  Lighten this key to enable the numerical arrow key. Respectively press 8, 2, 4, 6, the cursor will move up, down, left and right.





5.2.8 Start Volt- can be set in BDV test mode

Start Volt ranges from 100V to 5000V but cannot be larger than End Volt. Move the cursor to this zone, following soft keys will be displayed.

- ◇   They are coarse adjustment keys used to change Start Volt by 100V.
- ◇   They are fine adjustment keys used change Start Volt by 10V.
- ◇  Lighten this key to enable the numerical arrow key. Respectively press 8, 2, 4, 6, the cursor will move up, down, left and right.

5.2.9 End Volt- can be set in BDV test mode

End Volt ranges from 100V to 5000V but must be larger than Start Volt. Move the cursor to this zone, following soft keys will be displayed.



- ◇   They are coarse adjustment keys used to change End Volt by 100V.
- ◇   They are fine adjustment keys used change End Volt by 10V.
- ◇  Lighten this key to enable the numerical arrow key. Respectively press 8, 2, 4, 6, the cursor will move up, down, left and right.

5.2.10 Volt Step- can be set in BDV test mode

Volt Step ranges from 1% to 50%. The step voltage is calculated as following formula:

Step volt = Start Volt * Volt Step.

Move the cursor to this zone, following soft keys will be displayed.

- ✧  They are coarse soft keys used to change Volt Step by a resolution of 10%.
- ✧  They are fine soft keys used to change Volt Step by a resolution of 1%.
- ✧  Lighten this key to enable the numerical arrow key. Respectively press **8**, **2**, **4**, **6**, the cursor will move up, down, left and right.



5.2.11 Comparator

The comparator function allows you to set all comparators to ON or OFF. Once the comparator is turned off, the instrument cannot make any comparisons, but the test wave or the standard wave is also displayed on the measurement display page. Move the cursor to this zone, following soft keys will be displayed.

- ✧ **ON** Turn on the comparator.
- ✧ **OFF** Turn off the comparator
- ✧  Lighten this key to enable the numerical arrow key. Respectively press **8**, **2**, **4**, **6**, the cursor will move up, down, left and right.



5.2.12 Position (AREA SIZE, DIFF ZONE, PHASE DIFF)

Set the comparison ranges for AREA SIZE, DIFF ZONE and CORONA that range from 0 to 6000 (the value of the end position must be larger than that of the start position.). Use numeric buttons to enter the required value and press **ENTER** for confirmation. Move the cursor to this zone, following soft keys will be displayed.

- ✧  They are coarse adjustment soft keys used to change the value of position by 100.
- ✧  They are fine adjustment soft keys used to change the value of position by 10.
- ✧  Lighten this key to enable the numerical arrow key. Respectively press **8**, **2**, **4**, **6**, the cursor will move up, down, left and right.



5.2.13 Position (PHASE DIFF)

Set the zero-crossing position for PHASE DIFF that is to select a zero-crossing position for the comparison of phase difference. The zero-crossing position ranges from 2 to 99. Use numeric buttons to enter the required value and press **ENTER** for confirmation. Move the cursor to this zone, following soft keys will be displayed.

- ✧  They are fine adjustment soft keys used to change the zero-crossing position by 1 dot.
- ✧  Lighten this key to enable the numerical arrow key. Respectively press **8**, **2**, **4**, **6**, the cursor will move up, down, left and right.



5.2.14 DIFF (Limit) (AREA SIZE, DIFF ZONE, PHASE DIFF)

Set the limit values for comparison methods of AREA SIZE, DIFF ZONE, PHASE DIFF which range from 0.1% to 99.9% by a resolution of 0.1%. Use numeric buttons to enter the required value and press **ENTER** for confirmation. Move the cursor to this zone, following soft keys will be displayed.

- ✧  They are coarse adjustment soft keys used to change the limit value by a resolution of 1.0.
- ✧  They are fine adjustment soft keys used to change the limit value by a resolution of 0.1.
- ✧  Lighten this key to enable the numerical arrow key. Respectively press **8**, **2**, **4**, **6**, the cursor will move up, down, left and right.

5.2.15 DIFF (Limit) (CORONA)

Set the limit values for comparison methods of CORONA which range from 0 to 256 by a resolution of 1 dot. Use numeric buttons to enter the required value and press **ENTER** for confirmation. Move the cursor to this zone, following soft keys will be displayed.

- ✧  They are coarse adjustment soft keys used to change the limit value by a resolution of 10 dots.
- ✧  They are fine adjustment soft keys used to change the limit value by a resolution of 1 dot.
- ✧  Lighten this key to enable the numerical arrow key. Respectively press **8**, **2**, **4**, **6**, the cursor will move up, down, left and right.

5.3 Match Setup

In Match Setup interface, the sample handling for standard waveform of each test step can be set and checked. The setup of 8 channels (4 channels for TH2883S4-5) for the current selected step are displayed at the right corner of the interface. Red means the current mode of the channel is HIGH. Black means the current mode of the channel is LOW. White means the current mode of the channel is CLOSE. The page below is the waveform display zone. The collected standard waveform and other waveform display of the current step will be displayed on this zone. At the same time, Imp Volt, Samp, Time base and Test status. Figure 5-2 shows the match setup page.

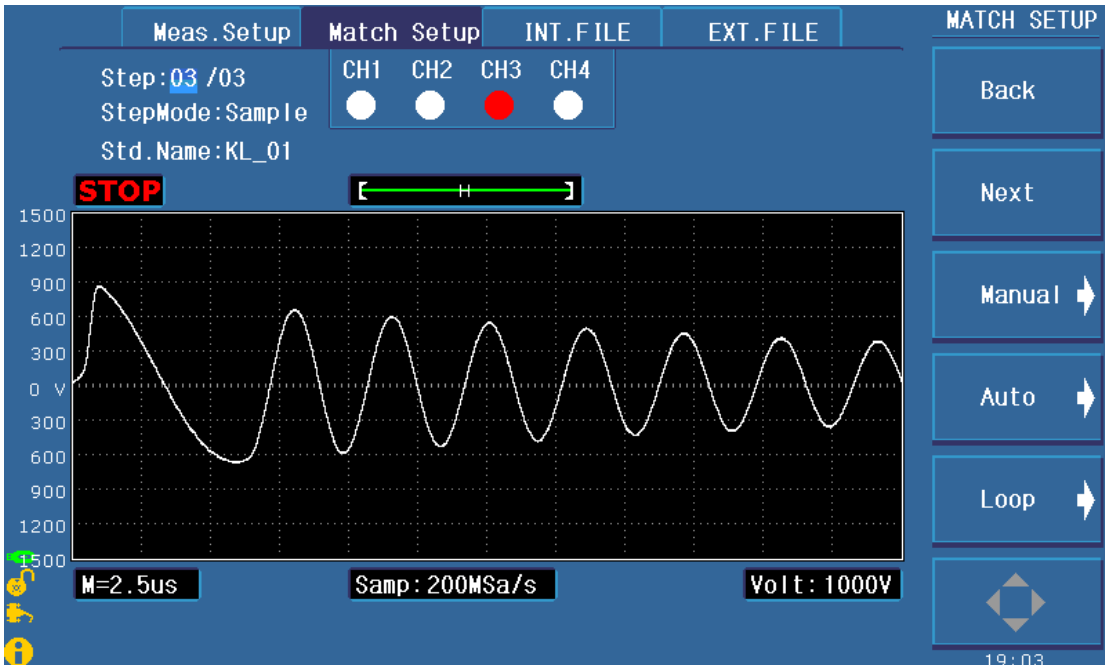





Figure 5-2 Match setup page

5.3.1 Step

Select the step set in Meas. Setup interface and make sample handling of standard waveform of each step. The instrument provides three kinds of sample mode: Manual, Auto and Loop.

- ◇ **Back** Enter into the last step.
- ◇ **Next** Enter into the next step.
- ◇ **Manual** It is available in **Sample** mode.
 - **Start** Start sample handling of the standard waveform. The standard waveform will be displayed in waveform display zone.
 - **Complete** Press this key to complete the acquisition of standard waveform.
 - **Average 1** Indicate the number of sample handling.
 - **Undo** Undo the current acquisition data of standard waveform. Press this key, the average time minus 1.
 - **Undo ALL** Undo all the acquisition data of standard waveform.
 - **Start** Start data acquisition of sample handling. Acquisition of several times and multiple sample data can be averaged.
 - **↓** Return to previous menu.
- ◇ **Auto** It is available in **Sample** mode.
 - **Start** The instrument will start collecting the standard waveform of sample at every sample frequency automatically. Finally, waveform display at appropriate frequency will be selected.
 - **↶** Turn down to load the sample waveform at lower frequency.

-  Turn up to load the sample waveform at higher frequency.
 - **Select** Select the sample waveform at current frequency as standard waveform.
 - **Select & Check** Make a sample test at the current frequency. If the comparison result is within the error range, select the sample waveform at current frequency as standard waveform and return to the Mainmenu; If the comparison result exceeds the error range, it will beeps on error and wait to restart sampling.
 - **Start** Enable automatic test.
 -  Return to previous menu.
- ◇ **Loop** It is available in **Sample** mode.
- **Start** The instrument will start collecting standard waveform, changing the frequency and sample circularly.
 - **Select** Select the sample waveform at current frequency as standard waveform
 - **Select & Check** Make a sample test at the current frequency. If the comparison result is within the error range, select the sample waveform at current frequency as standard waveform and return to the Mainmenu; If the comparison result exceeds the error range, it will beeps on error and wait to restart sampling.
 - **Start** Enable loop test.
 -  Return to previous menu.
- ◇  Lighten this key to enable the numerical arrow key. Respectively press **8**, **2**, **4**, **6**, the cursor will move up, down, left and right.

5.3.2 Mode

Select the stepmode. The instrument provides four kinds of stepmodes: None, Sample, SW.Copy and TW.Copy.

- ◇ **None** Select **None**, the instrument will not make acquisition comparison of standard waveform. Now, Manual, Auto and Loop are not available. **Std.Name** and **Step No.** are not available.
- ◇ **Sample** Make acquisition of standard waveform for DUTs. The instrument provides three kinds of sample mode: Manual, Auto and Loop. When Sample is selected, **Std.Name** is available.
- ◇ **SW.Copy** If the current step and other step share the same standard waveform, use SW.Copy to copy the captured standard waveform of other step directly. The use of SW.Copy is available when the inserted step is equal or greater than 2. When SW.Copy is selected, **Step No.** is available.
- ◇ **TW.Copy** If the captured waveform of the current step needs comparison test with the captured standard waveform of the last step, use TW.Copy to make a comparison with the standard waveform of the last step. The use of TW.Copy is available when the inserted step is equal or greater than 2. When TW.Copy



is selected, **Step No.** is available.

- ✧ Lighten this key to enable the numerical arrow key. Respectively press **8, 2, 4, 6**, the cursor will move up, down, left and right.

5.3.3 Std.Name-available in Sample mode

Std.Name is displayed when the mode is Sample, it is invalid in other mode.

- ✧ **Input** Press this key, input the filename and press the ENTER key to save it. If giving up operation halfway, press ESC softkey to quit. If user press the **ENTER** button without entering the file name, the file will be saved as the default name-<Unnamed>. Pressing ESC can exit the operation of saving file. Letters from A to Z, numbers from 0 to 9, and underline, etc. can be used for a file name.
 - ☛ **Enter rules: Pressing a numeric key, the corresponding letters or characters will be displayed on the screen. If user wants to input a number, the numeric key should be pressed again. While a letter or character is needed, then the soft key corresponding to the letter or the character should be pressed.**
- ✧  Lighten this key to enable the numerical arrow key. Respectively press **8, 2, 4, 6**, the cursor will move up, down, left and right.

5.3.4 Step NO.-available in SW.Copy

Other step name that can be selected is displayed as Step.XX. For example, Step.01 indicates that the user chooses the first step, Step.02 indicates that the user chooses the second step.....and so on. In SW.Copy mode, the displayed **Step No.** is of the step needs to copy the the standard waveform. In TW.Copy mode, the displayed **Step No.** is of the step needs to make a comparison. **Step NO.** is displayed in **SW.Copy** or **TW.Copy** mode, it is invalid in other mode.

- ✧ **Back** Select the previous step to make SW. Copy or TW.Copy test.
- ✧ **Next** Select the latter step to make SW. Copy or TW.Copy test.
- ✧  Lighten this key to enable the numerical arrow key. Respectively press **8, 2, 4, 6**, the cursor will move up, down, left and right.

5.4 Int. File

TH2883 series can save parameters that are set by user to the internal non-volatile memory in file format. User can load the file to use these parameters instead of resetting. The internal memory can store 100 groups of files including files of measure parameters, compare parameters, etc. Figure 5-3 shows the page of internal file.

saved as the default name-<Unnamed>. Pressing ESC can exit the operation of saving file. Letters from A to Z, numbers from 0 to 9, and underline, etc. can be used for a file name.

☞ **Enter rules: Pressing a numeric key, the corresponding letters or characters will be displayed on the screen. If user wants to input a number, the numeric key should be pressed again. While a letter or character is needed, then the soft key corresponding to the letter or the character should be pressed.**

- ✧  Lighten this key to enable the numerical arrow key. Respectively press 8, 2, 4, 6, the cursor will move up, down, left and right.

5.5 Ext. File

Figure 5-4 shows the page of external file.

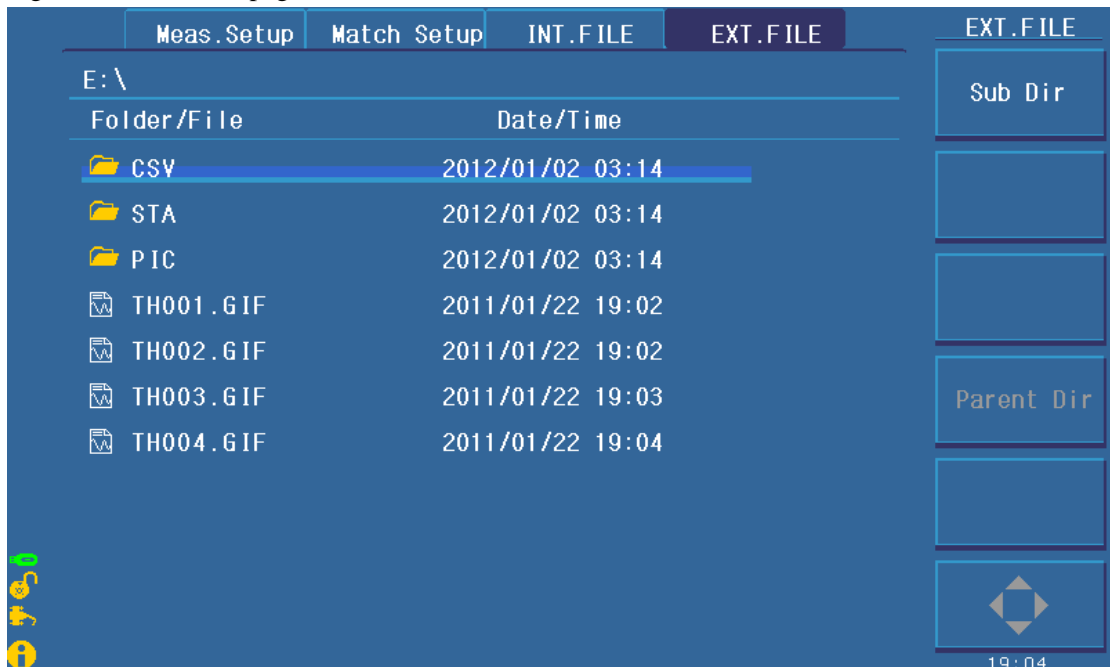

Figure 5-4 External file

The set parameters can be saved to a U disk (external file) in file format. External file storage supports three extension names: .STA, .TXT, .CSV. Only .STA file has file load function. Soft keys in the external file page are as follows:

- ✧ **Sub Dir** Enter the sub-directory. Using the arrow key or the roller to choose a file, press **Sub Dir** to enter the sub-directory.
 - ☞ **Note: When the cursor is locating in the folder zone, pressing the roller down will also enter the sub-directory.**
- ✧ **Parent Dir** Return to the parent directory.
- ✧ **Create** Create a new folder. Press **Create** and then input the name of the file folder. End the creation of new folder by press **ENTER**. If user presses **ENTER**

without inputting the folder name, the folder will be named as the default name-<FOLDERxx> (xx is a number ranging from 01 to 99.). Pressing **ESC** can exit the operation of creating. Letters from A to Z, numbers from 0 to 9, and underline, etc. can be used for a file name.

① Note: Users are recommended to use self-defined folder name. The default name ranges from FOLDER01 to FOLDER 99.

- ✧ **Save** Press this key to save a file. Move the arrow key to choose the catalog storing the file. Press the **Save** soft key and then enter the file name.
 - Press **ENTER** to end this operation. If the **ENTER** button is pressed without inputting the file name, the default name is FILExxx.STA (xxx ranges from 001 to 999.).
 - Press **.**, soft keys **.STA**, **.TXT** and **.CSV** will be displayed in the soft key zone.
 - ◆ Press **.STA**, the file will be save as **.STA** file. If the file name is not input, the file will be named as the default name FILExxx. STA (xxx ranges from 001 to 999.).
 - ◆ Press **.TXT**, the file will be save as **.TXT** file. If the file name is not input, the file will be named as the default name FILExxx. TXT (xxx ranges from 001 to 999.).
 - ◆ Press **.CSV**, the file will be save as **.CSV** file. If the file name is not input, the file will be named as the default name FILExxx. CSV (xxx ranges from 001 to 999.).

① Note: Users are recommended to use self-defined folder name. The default name ranges from FOLDER001 to FOLDER 099.

- ✧ **Load** Load a file saved in an external U disk. Using the arrow key or the roller can choose the desired file. Press **Load**. If the selected external file is needed to load to the internal RAM, press **YES**, otherwise **NO**.

①Note: Although the instrument supports three file formats, .STA, .TXT and CSV, only .STA file can be loaded to internal RAM.

- ✧ **Delete** Delete saved files. Press **Delete**. Then choose **YES** to delete the file, otherwise **NO** to cancel the delete operation.
- ✧ **Copy to I:** Copy external files (in U disk) to internal file list. Using the arrow key or the roller can select the desired file. If the selected file is needed to copy to the internal file list, press **Copy to I:** and then choose **YES**, otherwise choosing **NO** to give up this operation. Press **ENTER** to end coping. In numeric input state, press **ESC** to exit from this page.

- ✧  Lighten this key to enable the numerical arrow key. Respectively press **8**, **2**, **4**, **6**, the cursor will move up, down, left and right.

Chapter 6 Introduction to [SYSTEM]

Press **[SYSTEM]** to enter **System**. This is a toggle key, the press of which will make the displayed page toggled among **System**, **Parameter**, **Interface**, **About**.

6.1 System

Figure 6-1 shows the **System** page.

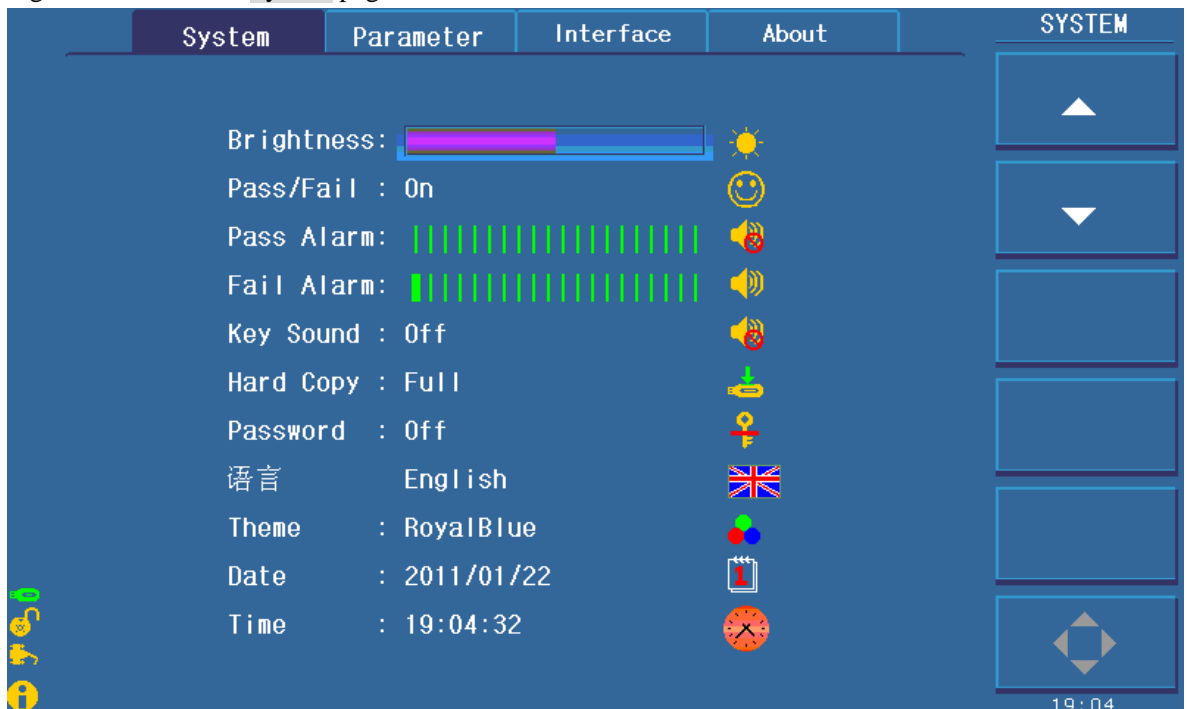



Figure 6-1 System

Parameters irrelevant to test performance can be set in this page.

- ✧ **Brightness**
- ✧ **Pass/Fail**
- ✧ **Pass Alarm**
- ✧ **Fail Alarm**
- ✧ **Key Sound**
- ✧ **Hard Copy**
- ✧ **Password**
- ✧ **Language**
- ✧ **Theme**
- ✧ **Date**
- ✧ **Time**

6.1.1 Brightness

Move the cursor to this zone, following soft keys will be displayed.

- ✧ ▲ ▼ They are soft keys used to increase and decrease the LCD display.
- ✧  Lighten this key to enable the numerical arrow key. Respectively press 8, 2, 4, 6, the cursor will move up, down, left and right.

6.1.2 Pass/Fail

Move the cursor to this zone, following soft keys will be displayed.

- ✧ On Turn on Pass/Fail display function.
- ✧ Off Turn off Pass/Fail display function.
- ✧  Lighten this key to enable the numerical arrow key. Respectively press 8, 2, 4, 6, the cursor will move up, down, left and right.

6.1.3 Pass Alarm

Move the cursor to this zone, following soft keys will be displayed.

- ✧ ▲ ▼ They are soft keys used to adjust the volume of the pass alarm. The lowest volume is mute.
- ✧  Lighten this key to enable the numerical arrow key. Respectively press 8, 2, 4, 6, the cursor will move up, down, left and right.

6.1.4 Fail Alarm

Move the cursor to this zone, following soft keys will be displayed.

- ✧ ▲ ▼ They are soft keys used to adjust the volume of the fail alarm. The lowest volume is mute.
- ✧  Lighten this key to enable the numerical arrow key. Respectively press 8, 2, 4, 6, the cursor will move up, down, left and right.

6.1.5 Key Sound

Move the cursor to this zone, following soft keys will be displayed.

- ✧ On Turn on the key sound.
- ✧ Off Turn off the key sound.
- ✧  Lighten this key to enable the numerical arrow key. Respectively press 8, 2, 4, 6, the cursor will move up, down, left and right.

6.1.6 Hard Copy

Move the cursor to this zone, following soft keys will be displayed.

- ✧ **Full** Full screen will be copied.
- ✧ **Wave** Only wave zone will be copied.
- ✧  Lighten this key to enable the numerical arrow key. Respectively press **8**, **2**, **4**, **6**, the cursor will move up, down, left and right.

① **Note: Wave is valid only in the measurement display page. In the other pages, the default copy zone is Full.**

6.1.7 Password

Move the cursor to this zone, following soft keys will be displayed.

- ✧ **On** Turn on the password function. When user turns on or unlocks the instrument, it is required to input password.
- ✧ **Off** Turn off the password function. When user turns on or unlocks the instrument, it is not required to input password.
Note: When turning off the password function, it is required to input the password.
- ✧ **Modify** This key is used to modify the password. The instrument will prompt user to input old password, new password and new password again in turn. (Press **ESC** to exit from modifying password.)

Note: Only numbers can be used as password.

- ✧  Lighten this key to enable the numerical arrow key. Respectively press **8**, **2**, **4**, **6**, the cursor will move up, down, left and right.

6.1.8 Language

Move the cursor to this zone, following soft keys will be displayed.

- ✧ **中文** Choose Chinese as the display and operation language.
- ✧ **English** Choose English as the display and operation language.
- ✧  Lighten this key to enable the numerical arrow key. Respectively press **8**, **2**, **4**, **6**, the cursor will move up, down, left and right.

6.1.9 Theme

- ✧ RoyalBlue
- ✧ Seagreen
- ✧ Steelblue
- ✧ Indianred

6.1.10 Date

Date can be set in this zone. The display format is like 2011/05/04. Move the cursor to this zone, following soft keys can be used.

- ◇ ▲ ▼ They are soft keys used to adjust date by 1 day.
- ◇ ◀ ▶ Lighten this key to enable the numerical arrow key. Respectively press 8, 2, 4, 6, the cursor will move up, down, left and right.
- ☞ **Note: The date can be directly input by numeric keys. In the process of inputting numbers, soft keys are not available. User can press **ENTER** to terminate inputting (In the state of inputting, if it is required to exit from modifying, press **ESC**).**

6.1.11 Time

Time can be set in this zone. The display format is like 06:22:28. Move the cursor to this zone, following soft keys can be used.

- ◇ ▲ ▼ They are soft keys used to adjust time by 1.
- ◇ ◀ ▶ Lighten this key to enable the numerical arrow key. Respectively press 8, 2, 4, 6, the cursor will move up, down, left and right.
- ☞ **Note: The time can be directly input by numeric keys. In the process of inputting numbers, soft keys are not available. User can press **ENTER** to terminate inputting (In the state of inputting, if it is required to exit from modifying, press **ESC**).**

6.2 Parameter

Parameter interface is used to setup the three parameters of Wave Disp, Trig Mode and Delay Time. Figure 6-2 shows the page of Parameter.

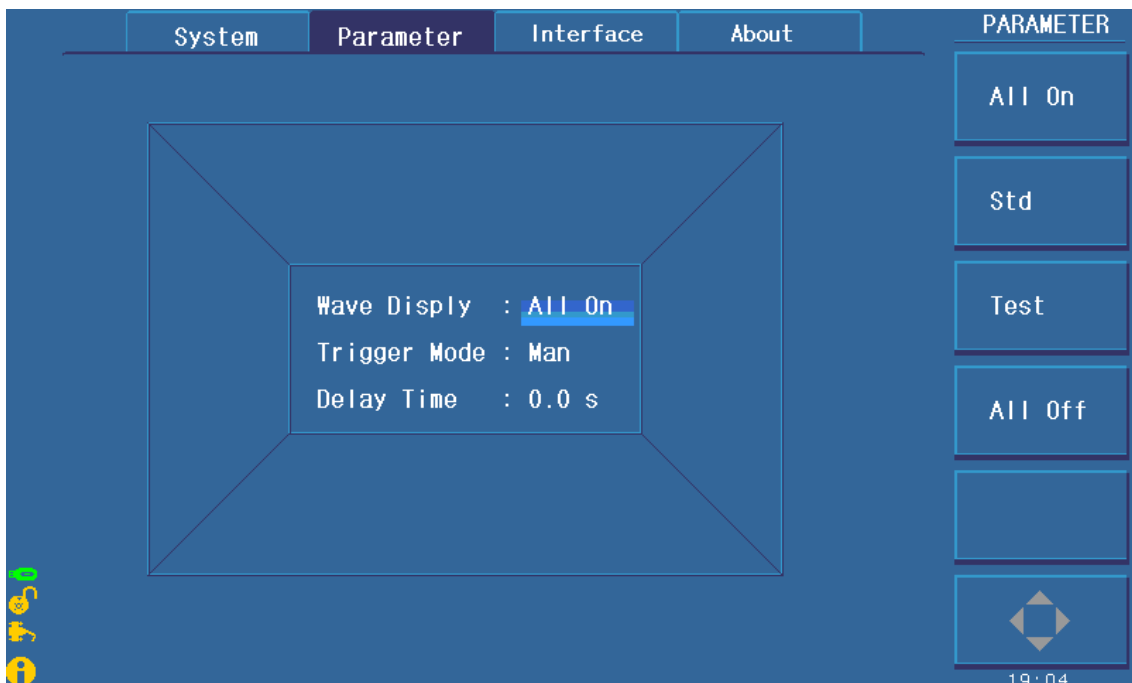



Figure 6-2 Parameter

6.2.1 Wave Disp

If user only wants the comparison result, the wave display can be switched off so as to obtain a test speed much faster.

Move the cursor to this zone, following soft keys will be displayed.

- ✧ **ALL ON** Both the standard waveform and the test waveform will be displayed on the screen at the same time. For the consumption of display time, the test speed will be decreased. This display will bring convenience for user to observe waveforms.
- ✧ **ONLY STD WAVE** In the phase of measurement, only the standard waveform will be displayed on the screen, so the measurement will be taken at the fastest speed. This way is suitable for users only needing the comparison result.
- ✧ **ONLY TEST WAVE** In this mode, only the test waveform is displayed thus it will take some time to refresh the tested waveforms after each test and the test speed will be decreased.
- ✧ **ALL OFF** With the exception of comparison result, none waveforms will be displayed, therefore the test speed is the fastest in this mode.
- ✧  Lighten this key to enable the numerical arrow key. Respectively press 8, 2, 4, 6, the cursor will move up, down, left and right.

ⓘ Note: In the latter two modes, when SEQ CYCLE or SINGLE CYCLE is selected, the standard waveform will disappear; when SINGLE SAMPLE is selected, none waveforms will be displayed. Thus it is highly recommended for user to turn on standard waveform.

6.2.2 Trig Mode

The instrument will perform a measurement only at the receipt of a trigger signal. TH2883 provides four kinds of trigger mode: MAN (manual including foot control), EXT (external), INT (internal) and BUS. Trigger signals only in the current trigger mode can be received and will be valid only on the MEAS DISP page. Move the cursor to this zone, following soft keys will be displayed.



- ✧ **MAN** This is the default trigger mode. Pressing **START** or using the foot switch to start a measurement.
- ✧ **EXT** Via HANDLER interface, input a negative TTL pulse (more than 1 μs) from external to the instrument, the rising edge of which will form a trigger impulse.
- ✧ **INT** When the trigger mode is set to this mode, TH2883 starts a measurement once **START** is pressed on the **MEAS DISP** page, and then the instrument will continuously repeat measurements until **MEAS EXIT** soft key is pressed.

- ✧ **BUS** TRIGGER commands are sent to TH2883 via RS232SC, USBTMC, USBCDC or LAN interface.
- ✧  Lighten this key to enable the numerical arrow key. Respectively press 8, 2, 4, 6, the cursor will move up, down, left and right

6.2.3 Delay Time

Delay time refers to the time between the end of a measurement and the start of the next measurement. The delay function is only available when trigger mode is set to INT trigger mode. The trigger delay time can be set from 0.1s to 99s by 0.1 steps.

Move the cursor to this zone. User can input the delay time by pressing numerical keys and **ENTER** for confirmation. The input unit is s. Following soft keys can also be used to set the delay time.

- ✧  They are coarse adjustment keys used to change the delay time by 1.0s.
- ✧  They are fine adjustment keys used to change the delay time by 0.1s.
- ✧  Lighten this key to enable the numerical arrow key. Respectively press 8, 2, 4, 6, the cursor will move up, down, left and right.

6.3 Interface

In this page, information about **RS232** interface, **USB** interface (USBTMC or USBCDC), **LAN** interface and interface setups can be set, as shown in figure 6-3.

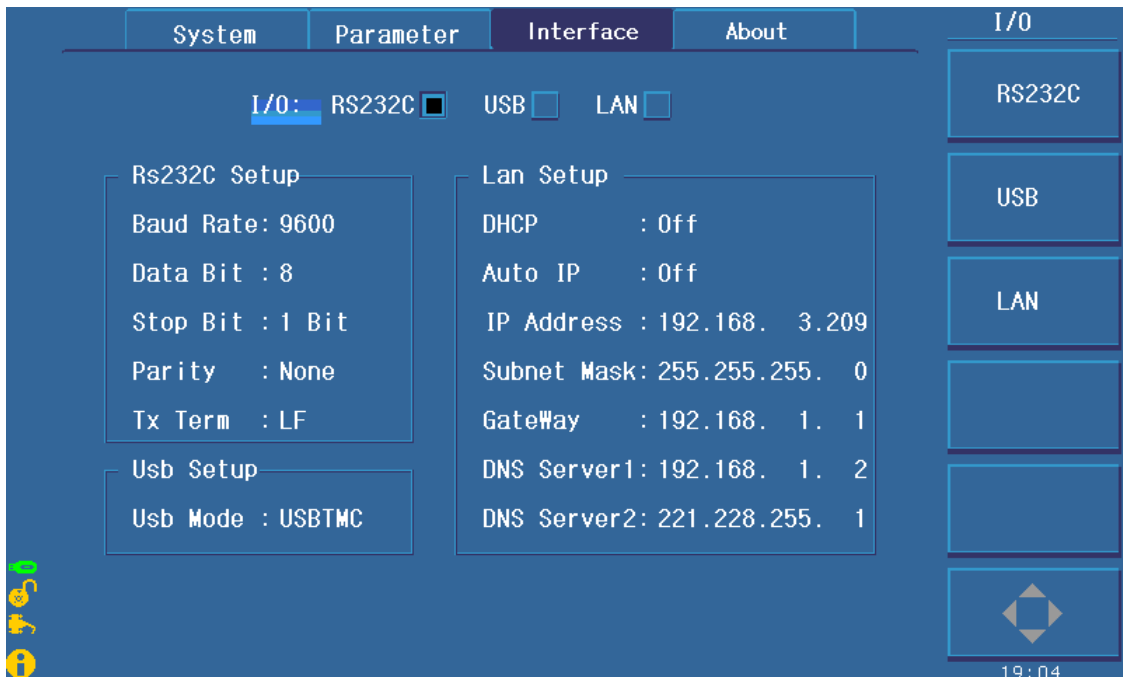



Figure 6-3 Interface

6.3.1 I/O

Move the cursor to the **I/O** zone, following soft keys will be displayed.

- ✧ **RS232C** Set RS232 interface as the I/O interface.
- ✧ **USB** Set USB interface as the I/O interface.
- ✧ **LAN** Set LAN interface as the I/O interface.
- ✧  Lighten this key to enable the numerical arrow key. Respectively press **8**, **2**, **4**, **6**, the cursor will move up, down, left and right.

ⓘ Note: Once an interface is selected, the cursor can only move in the corresponding zone. For example, when RS232C interface is selected, the cursor can move only in the RS232C setup zone.

6.3.2 TH2883 RS232C interface

RS-232 standard, also called as asynchronous serial communication standard, has already been widely used for data communication between computers, computer and external equipment. RS is the English abbreviation of Recommended Standard; 232, the standard number. This standard is issued by IEA in 1969, which rules to send one bit in a data line every time.

As most serial interfaces, the serial interface of TH2883 is also not strictly based on RS-232 standard but only uses the smallest subset of this standard. The signals are listed in the following table.

Signal	Code	Connector pin number
Transmitted data	TXD	2
Received data	RXD	3
Signal ground common	GND	5

Table 6-1 RS-232 signal and pin number

The reason is that the use of three lines is much more inexpensive and much simpler than that of five lines or six lines, which is the biggest advantage of using serial interface for communication. The connection of the instrument with PC is shown in figure 6-4:

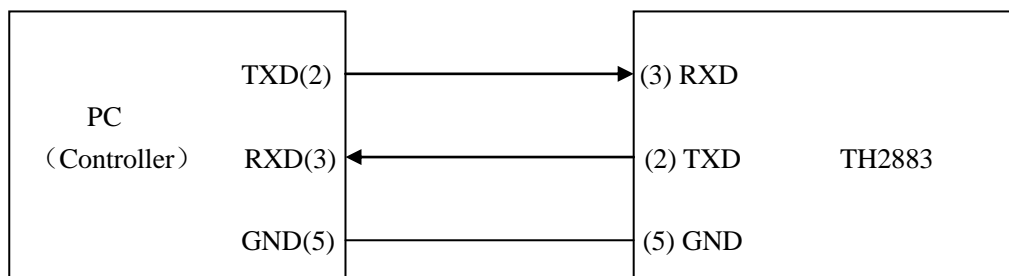

Figure 6-4 Connection of the instrument with PC

Figure 6-4 shows that the serial interface pin definition of this instrument is different from that of

9 pin connector used in IMB AT compatible computer. User can purchase the serial interface cable from our company.

TH2883's baud rate, data bit, stop bit, parity bit and Tx term can be set. See the following 5 sections for details.

Commands of TH2883 comply with SCPI standard. When a command string is sent to the instrument, Tx term must be attached to the end of the string. The length of a SCPI command string that TH2883 can receive every time is up to 2k Byte.

See command reference for data format that the instrument sends to PC.

6.2.2.1 Baud Rate

TH2883 provides five baud rates: 4800bit、9600bit、19200bit、38400bit、115200bit. Move the cursor to this zone, following soft keys can be used.

- ✧ ▲ ▼ They are soft keys used to choose the required baud rate.
- ✧ ◀ ▶ Lighten this key to enable the numerical arrow key. Respectively press 8, 2, 4, 6, the cursor will move up, down, left and right.

6.2.2.2 Data Bit

Move the cursor to this zone, following soft keys can be used.

- ✧ 6 Set the data bit to 6 Bit.
- ✧ 7 Set the data bit to 7 Bit.
- ✧ 8 Set the data bit to 8 Bit.
- ✧ ◀ ▶ Lighten this key to enable the numerical arrow key. Respectively press 8, 2, 4, 6, the cursor will move up, down, left and right.

6.2.2.3 Stop Bit

Move the cursor to this zone, following soft keys can be used.

- ✧ 1 Bit Set the stop bit to 1 bit.
- ✧ 1.5 Bit Set the stop bit to 1.5 bit.
- ✧ 2 Bit Set the stop bit to 2 bit.
- ✧ ◀ ▶ Lighten this key to enable the numerical arrow key. Respectively press 8, 2, 4, 6, the cursor will move up, down, left and right.

6.2.2.4 Parity

Move the cursor to this zone, following soft keys can be used.

- ✧ None Set the parity as None.
- ✧ Odd Set the parity as Odd.
- ✧ Even Set the parity as Even.
- ✧ ◀ ▶ Lighten this key to enable the numerical arrow key. Respectively press 8, 2, 4, 6, the cursor will move up, down, left and right.

6.2.2.5 Tx Term

Move the cursor to this zone, following soft keys can be used.

- ✧ LF Set the Tx term as \n (ASCII is 0x0A).
- ✧ CR Set the Tx term as \r (ASCII is 0x0D).
- ✧ LFCR Set the Tx term as \r\n (ASCII is 0x0D and 0x0A).

- ✧  Lighten this key to enable the numerical arrow key. Respectively press 8, 2, 4, 6, the cursor will move up, down, left and right.

6.3.3 USB interface

Move the cursor to this zone, following soft keys can be used.

- ✧ **USBCDC** Set USBCDC interface as the USB interface.
- ✧ **USBTMC** Set USBTMC interface as the USB interface.
- ✧  Lighten this key to enable the numerical arrow key. Respectively press 8, 2, 4, 6, the cursor will move up, down, left and right.

6.2.3.1 USBCDC interface

Choosing USBCDC, user can configure the USB interface as a virtual serial port.

Connect USB interfaces of TH2883 and a PC through a USB cable.

Install drive: Select the path of the drive file-TH2883-vcom.inf.

After the drive is installed, user can see “TH2883 USB Vcom Port (COM3)” in the device manager, as shown in figure 6-6.

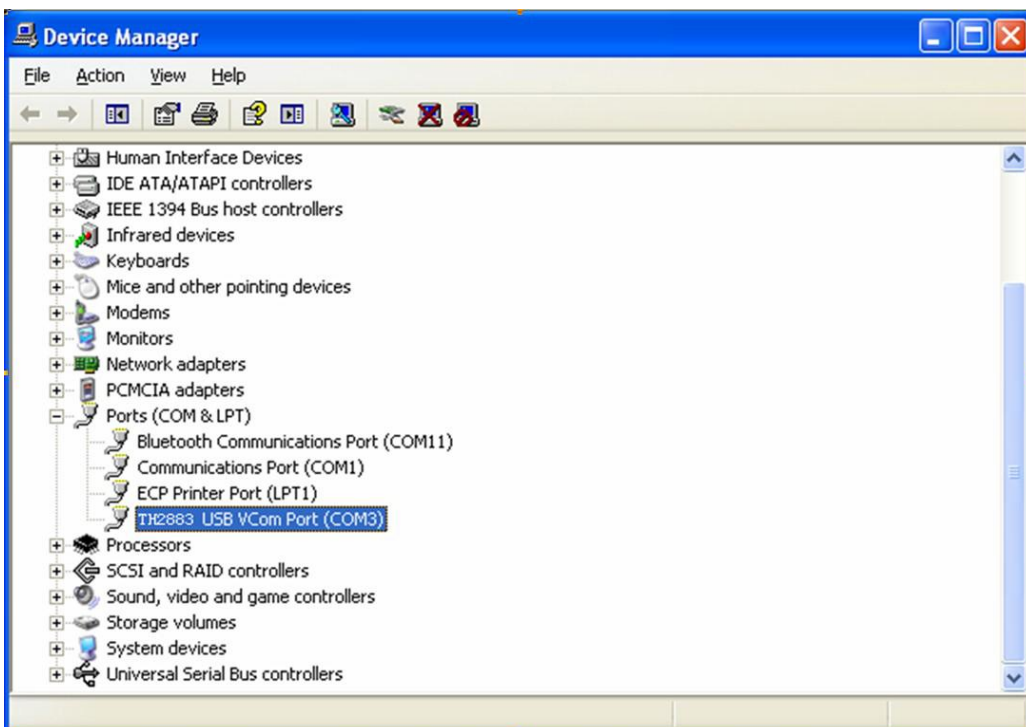

Figure 6-6 USBCDC has been installed

Now, usb VCom port acts as a serial port. When PC has no serial port, the communication software based on this serial port can be used as USB virtual serial port.

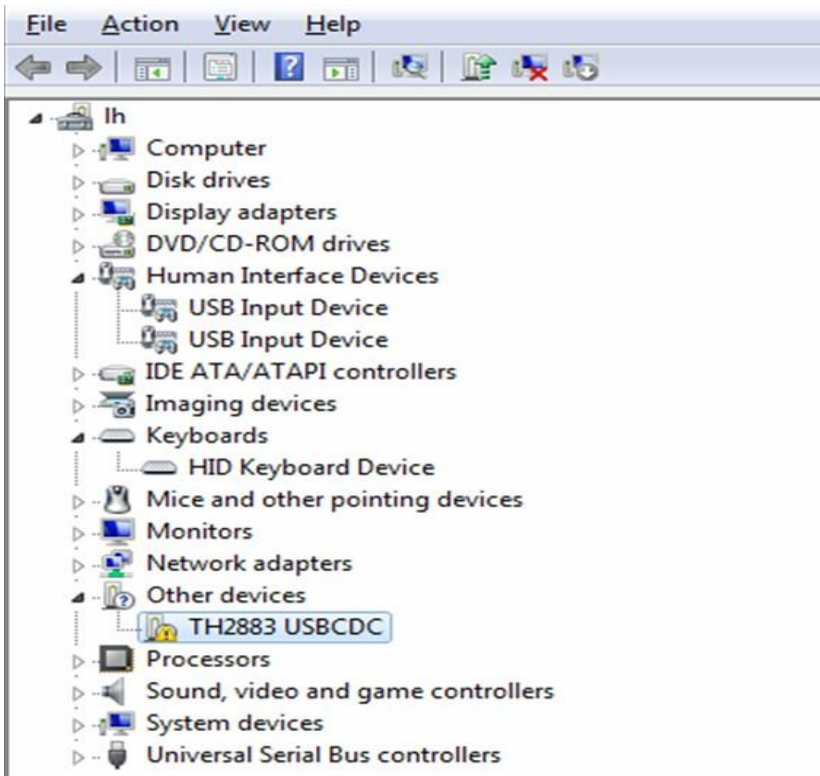

Figure 6-7 USB CDC has not been installed.

6.2.3.2 USBTMC interface

USB (Universal Serial Bus) remote control system controls the instrument through the USB interface. This connection conforms to USBTMC-USB488 and USB2.0 protocols.

Connect USB interfaces on PC and TH2883 through a USB cable.

Install drive: The installing steps of USBTMC are the same as that of USB CDC, see 6.2.3.1 for reference. When the installation of drive is finished, user can see “USB Test and Measurement Devices” in the device manager of PC, as shown in figure 6-8.

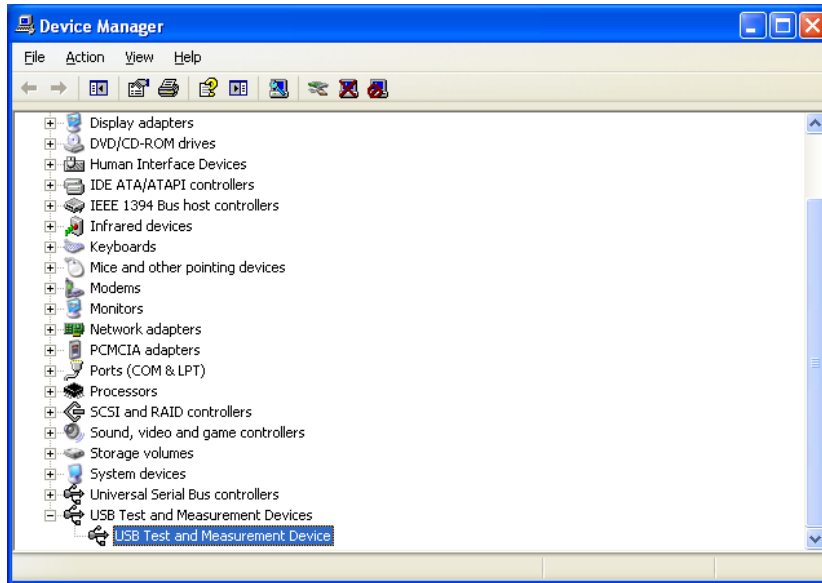

Figure 6-8 PC has installed USBTMC drive

When user is using USBTMC interface, labview software can be used to access the instrument. Tonghui provides Labview software for controlling TH2883. See Labview instruction manual for more details.

6.3.4 LAN interface

LAN (Local Area Network) can access TH2883 by two ways.

- (1) Access TH2883 by a browser.
- (2) Access TH2883 by Labview software.

System configuration

TH2883 is connected to a PC by a crossover network cable. If TH2883 is connected to a router, peer to peer network cable should be used.

Parameter settings

Select LAN interface in the interface page to enter the LAN setup page. Now you can set the following parameters: IP address, SUB MASK, gateway and DNS. Refer to the PC (connecting with TH2883) network parameter setups for TH2883 LAN parameter setups. For example: PC (connecting with TH2521) network parameter setups are shown in figure 6-9, TH2883 network parameter setups are shown in figure 6-10.

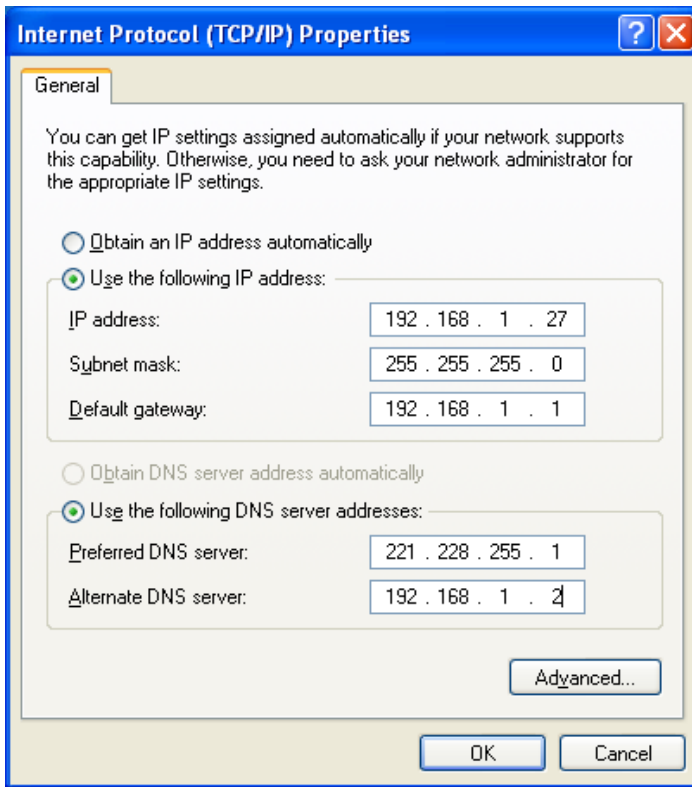

Figure 6-9 Network parameters of Host computer



Figure 6-10 Network parameters of TH2883

6.2.4.1 Access TH2883 through a browser

When TH2883 is accessed through a browser, it acts as a WEB server. User can access TH2883

by Internet Explorer (IE6.0 or upgraded version).

Steps of the access to TH2883 through a browser (assume that the instrument IP is 192.168.1.140)

- (1) Start up Internet Explorer.
- (2) Input <http://192.168.1.140/> in the address zone and then press ENTER to finish inputting.
- (3) The startup screen of Web server is shown as figure 6-11.

Tonghui® *TH2883 Impulse winding Tester*

Welcome to your **LXI**

Web-Enabled TH2883 Impulse winding Tester

Information about this web-enabled Instrument

Instrument	TH2883 Impulse winding Tester
Serial Number	288320090001
Description	TONGHUI TH2883
Host name	TH2883
IP Address	192.168. 1.140
VISA TCP/IP Connect String	TCPIP0::192.168. 1.140::INSTR
Firmware Revision	1.0
MAC Address	0-30-d3- e-f8-e3
SCPI TCP/IP Socket Port	4024
LXI Class	C
LXI Version	1.0

Note: Use the navigation item on the left to access your TH2883 and related information.
Copyright (c) Tonghui Electronics. 2009

Figure 6-11 Access to TH2883 through a browser

- (4) Click the item link (as circled by the red line in above figure) on the left side of the web page to enter the corresponding web page.

6.2.4.2 Access TH2883 through the Labview software

User can control TH2883 through Labview software. See Labview instruction manual for more details.

6.4 About

The About page shows some relevant information of the instrument, such as Model Number, Serial number, Firmware Version, System Version. There are two soft keys available: Reset, Factory. Figure 6-12 shows the About page.

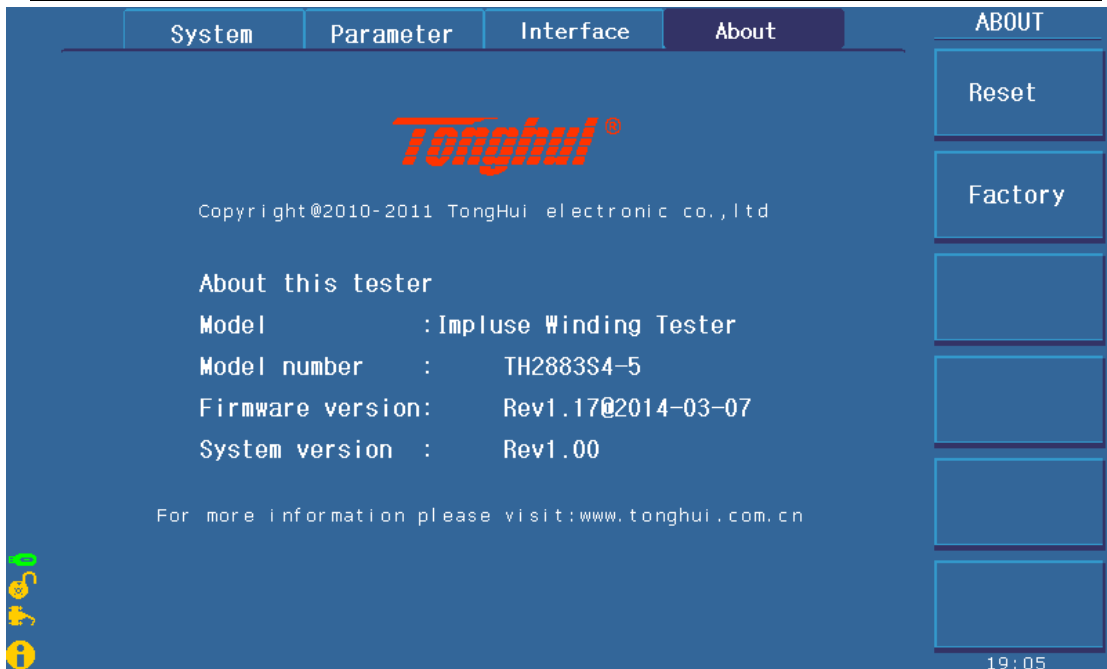

Figure 6-12 About

Following soft keys can be used in the About page.



- ✧ **Reset** Press this key to reset the instrument.
- ✧ **Factory** Press this key to reset the instrument to factory settings.

Chapter 7 User guide

7.1 Use of keys

7.1.1 Use of the roller

The roller can be used as a roller and a key. The roller can be rotated in clockwise and anti-clockwise directions, thus achieving parameter setups.





1. Indicate operations to the displayed waveform. Press the roller, if the icon  is displayed, user can amplify or zoom the tested waveform. Press this roller again, if the icon  is displayed, in the state that the waveform is amplified user can shift the waveform right or left. Another press of the roller will disable the amplification and the shift functions.
2. Enable the roller. In the measurement display page, if the icon  is displayed on the soft key, press the soft key to enable the roller. When this icon is lightened, the roller can be used; otherwise it is darkened, all functions of the roller will be invalid.
3. Choose and modify parameters. Revolve the roller in the purpose of moving the cursor to the parameter to be modified. Press the roller to choose the parameter and then revolve the roller to modify its value. When the value is modified, press the roller again to confirm and exit from the modification.

7.1.2 Switch the display page

There are three function pages displayed on the instrument: **DISP**, **STEUP** and **SYSTEM**.

1. **DISP** Press this key to enter the measurement display page.
2. **SETUP** Press this key to enter the parameter setup page. Continuously press this key, the display page will toggle among **Setup**, **Int. File**, and **Ext. File**.
3. **SYSTEM** Press this key to enter the system setup page. Continuously press this key, the display page will toggle among **System**, **Interface** and **About**.

7.1.3 Numeric arrow key

Lighten this icon  to enable this key. Respectively press the four keys, , , , , the cursor will move up, down, left and right. When the icon becomes dark, the numerical arrow key is disabled.

7.2 Basic measurement

Start up the instrument to enter the default measurement display page. The primary display zone shows the tested waveform. When Single Display is selected in Disp Setup, the secondary one shows parameters of corona or test.

7.2.1 Non-standard test

This test is applicable to trial sample test.

Switch on the instrument at the test impulse voltage of 1000V and the sample rate of 50MSa/s. Connect the test cable to DUT and press **START**, thus a test for DUT is done. Waveforms of the damping oscillation will be displayed in the primary display zone, observe the density of the waveforms and then modify the sample rate and repeat above processes. When Single Display is selected in Disp Setup, the secondary display zone shows the corona value, which is tested at high voltage test impulse and directly representing the insulation performance of DUT.

7.2.2 Sample test for standard wave

This test is applicable to batch test.

Press **SETUP** key to enter into the **Meas Setup** interface. After selecting the corresponding step channe, enter into the **Match Setup** interface. Select the corresponding step and select **Sample** in mode. Set the cursor in Step, choose **Auto** to enter the page of auto sample function. Press the **Start** soft key to automatically change the test frequencies. After a loop test for DUT is done, a waveform, most suitable for observing test, will be selected. Press **Select** to finish the acquisition of standard waveform. Replace a DUT and then press the **START** button to start the test. Set some criteria to judge the DUT to be good or bad.

7.3 BDV test

Determine an impulse voltage appropriate to test.

The applied voltage has little effect on the turn-to-turn short test and the layer-to-layer short test of coil, but the amplitude of the applied impulse voltage has a great impact on the insulation test of coil. TH2883 solves the problem of how to set an appropriate voltage. When it is required to determine an appropriate voltage for a kind of new product or for trial test, except the industrial specified voltage, TH2883 can find out the appropriate test voltage by switching on the BDV test function.

Enter the setup page and turn on BDV test. After setting start voltage, end voltage and step voltage, turn on the corona comparison and return to the measurement display page. Press **START** to start the test on DUT from the start voltage and then raise the voltage by step voltage. By observing the corona discharge (corona transition value), the voltage can be determined. 70~80% of the voltage is appropriate for test voltage.

7.4 Technology application

7.4.1 Test objects

1. Turn-to-turn and layer-to-layer short

Turn-to-turn short refers to the short caused by the insulation damage between turns. Layer-to-layer short occurs in the coil consisting of multiple layers. There are two kinds of short: direct short and pull arc short, both of which are shown as more dissipation.

2. Bad coil

The different number of coils will cause the variation of inductance, which is reflected as the change of oscillation period.

3. Corona discharge

Due to the use of impulse high voltage, if the insulations between the coil and layer and terminal are not strong enough, operator can observe the discharge and the corona discharge phenomenons. The corona discharge that can be captured by the impulse winding tester has weak energy. Instead of influencing the attenuation oscillation wave, it is only displayed as discrete jumping points around the waveform of high potential.

4. Material of magnetic core

Whether a magnet is used in the coil as the magnetic core or the magnet is poor, above conditions of the magnet will influence the inductance and the dissipation. Likewise, if air gas is designed in the magnetic core, the size of which will also have an impact on the inductance and the dissipation. Effects mentioned above will show as changes of the attenuating vibration period and the attenuation degree.

7.4.2 Select comparison method

Area size comparison is mainly used to compare the energy consumption.

Differential area comparison is sensitive to energy consumption and inductance change.

Corona comparison method is the best one for testing internal insulation of the coil.

Differential phase comparison is the most suitable one to show the inductance difference.

To test turn-to-turn short or layer-to-layer short, it is recommended to use Area Size comparison.

Poor coil can be recognized by Differential Phase comparison.

The insulation performance has some impacts on the life span of the coil products. For this reason, when the test occasion requires high standard of insulation performance, corona comparison must be switched on.

The material difference of magnetic core can be tested by Area Size comparison, Differential Area comparison or Corona comparison.

Both Area size comparison and corona comparison can be used to test coils of motor, solenoid and relay. Area size comparison, according to energy dissipation, can effectively detect layer-to-layer short and circle-to-circle short, while corona comparison is mainly applied to detect coil's internal insulation failure. If it is required to test inductance, differential area comparison should be selected.

7.4.3 Settings of comparison method

Sample the standard wave by ways mentioned in 7.2.2 and turn on the required comparisons dealt with in 7.4.2. For area size comparison and corona comparison, the setting values are determined by the two methods discussed below:

- A. ① If the condition is permitted, test 10 to 20 samples.
② Find out the entity that has the largest deviation value and then use it to make electrical test. If this one is good, enlarge the value by 20% and take it as the criteria (except corona).
③ When testing a product, if a boundary value is detected, repeat step ②.
④ The corona value is the transition one. The default value is 10.
- B. ① It is the same as A①.
② Take a coil to make failure test. Short two adjacent turns of coil and then make another test.
③ Take the differential area size of the sample as the high limit, the maximum unit differential area size of the sample as the low limit. Select an appropriate value as the criteria.
④ If the low limit is larger than the high limit, take the product that has the largest unit difference to make electrical test thus judging whether it is a poor product. Another way is to average samples (see 7.4.4) to take their differential area size or switch off the test method and directly take the corona comparison method.
⑤ It is the same as A④.

7.4.4 Select standards

1. Set test voltage. Then observe the corona value under non-standard test mode (7.2.1).
2. Sample the standard wave by methods mentioned in 7.2.2. Test 10 to 20 samples and select products that have the most similar differences.
3. Take the selected products to make sample average (5.3.1 Manual) and choose the final result as the standard wave.
4. Results obtaining after procedures 1-3 can be taken as the standards.

7.4.5 Chart for differential area

In the process of BDV test, the secondary display zone displays not only the extraction

value of the corona but also the chart record of differential area after each test. The chart can help user observe the changing regularity of the area differences during the test from the start voltage to the end voltage.

Chapter 8 Command reference

8.1 Command structure

TH2883 series has two types of commands: GPIB common commands and SCPI commands. The GPIB common commands are defined in IEEE std.488.2-1987, and these commands are common for all devices. Not all GPIB commands are supported by the TH2883 series. The SCPI commands are used to control all of the TH2883's functions. The SCPI commands are tree-structured and three-level deep. (The highest level commands are called the subsystem commands in this manual.) So the lower level commands are legal only when the subsystem commands have been selected. A colon (:) is used to separate the higher level commands and the lower level commands. See Figure 8-1 for a sample.

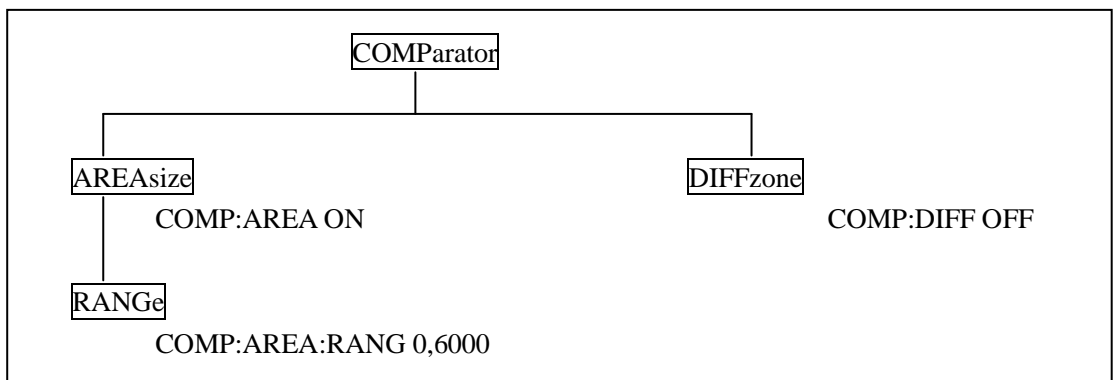

Figure 8-1 Command Tree

Basic rules of commands structure:

- Letter case (upper and lower) is ignored.
For example: COMP:AREA ON = comp:area on = Comp:aRea On
- Space (_ indicates a space) must not be placed before and/ or after a colon (:).
For example: COMP _:_ AREA ON → COMP:AREA ON
- Space is used to partition off command and parameter. Commands locate before space and their corresponding parameters put after space.
For example: COMP:AREA ON, AREA is command, ON is parameter.
- Some command has no parameter.
For example: Trigger command-TRIG, Standard waveform choosing command: SWAVE:CHOOSE
- The command can be completely spelled out or in abbreviated type. (The rules of command abbreviation are described later in this section, and abbreviation is spelling out in upper letter

case.)

For example: COMPARATOR:AREASIZE ON = COMP:AREA ON

- The command header should be followed by a question mark (?) to generate a query for that command.

For example: COMP:AREA?

Multiple command rules:

The semicolon (;) can be used as a separator to execute multiple commands on a single line. The multiple command rules are as follows.

- Commands at the same level and in the same subsystem command group can be separated by a semicolon (;) on a multiple command line.

For example: COMP:AREA:STAT ON;RANG 0,6000

STA ON and RANG 0,6000 are commands in the same level and subcommands under AREA.

- To restart commands from the highest level, a semicolon (;) must be used as the separator, and then a colon (:), which shows that the restarted command is a command at the top of the command tree, must follow.

For example: COMP:AREA:STAT ON::COMP:AREA:RANG 0,6000

- The GPIB common commands can be placed in previous, middle or last on a multiple command line, partitioned off with semicolons.

For example: COMP:AREA ON;*trg;DIFF ON

Short-form rules:

- If complete commands and parameters (called long form afterwards) have four characters or less, the long form and short form are the same.
- When the long form has more than 4 characters:
 1. And if the 4th character is a vowel, the short form is the first 3 characters of the long form.
 2. If the 4th character is not a vowel, the short form is the first 4 characters.

For example:

TIME abbreviates to TIME.

TRIGger abbreviates to TRIG.

DELeTe abbreviates to DEL.

FREQUency abbreviates to FREQ.

- If the long form mnemonic is defined as a phrase rather than a single word, then the long form mnemonic is the first character of the first word(s) followed by the entire last word. The above rules, when the long form mnemonic is a single word, are then applied to the resulting long form mnemonic to obtain the short form.

For example: Mass MEMory abbreviates to MMEM (long form is MMEMory)

Impulse VOLTage abbreviates to IVOLT(long form is IVOLTage)

- ☛ **NOTE: At the process of commands, the instrument does not distinguish letter case**

including units.

For example: disp:page meas = DISP:PAGE MEAS = DiSp:PAGE MEAs

8.2 Notation conventions and definitions

- The following characters are used in the command syntax.
 - : A colon is used to separate the higher level commands and the lower level commands.
 - ; The semicolon can be used as a separator to execute multiple commands on a single line.
 - * Asterisk is used to indicate that the command followed is a common command.
 - ? A question mark is used to generate a query for the command in front of it.
 - , Comma is used to separate the multi-parameters in the command.
 - _ White space is used to separate the command and the parameters.
 - "" Double quotation marks indicate that the enclosed text is string data.
- The following characters will be used in this chapter to describe GPIB commands.

NR1	Integer numeric data	For example: 123
NR2	Fixed point numeric data	For example: 12.3
NR3	Floating point numeric data	For example: 12.3E+5
NL	New Line character (decimal 10) is the end of the input/output string.	
^END:	EOI terminator signal of IEEE-488 bus.	
< >	Angular brackets enclose words or characters that are used to symbolize a program code parameter or a GPIB command.	
[]	Square brackets indicate that the enclosed items are optional.	

8.3 Command reference

TH2883 subsystem commands:

- | | | |
|---------------|-----------------|-------------------|
| ● DISPLAY | ● COMPARator | ● Impulse VOLTage |
| ● Sample RATE | ● Standard WAVE | ● TRIGger |
| ● FETCh? | ● MEASure | ● ABORt |
| ● STATistic | ● WADJust | ● MMEMory |
| ● MassSTEP | ● WaveSTEP | |

GPIB common commands:

- | | | |
|--------|--------|--------|
| ● *RST | ● *TRG | ● *IDN |
|--------|--------|--------|

8.3.1 DISPlay subsystem commands

The DISPlay subsystem commands set the display page. Figure 8-3 shows the command tree of the DISPlay subsystem commands.

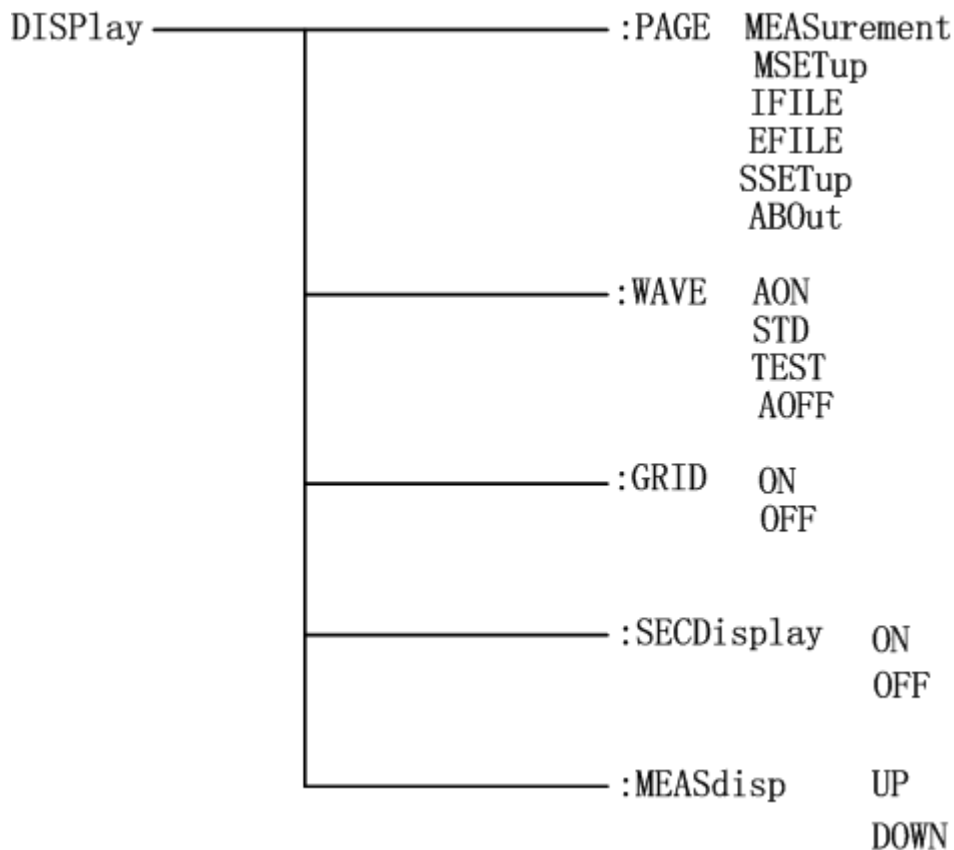

Figure 8-2 DISPlay subsystem command tree

The :PAGE command sets the display page. The :PAGE? query returns the abbreviated page name displayed on the LCD screen.

Command syntax: DISPlay:PAGE <page name>

<page name> are as follows:

MEASurement sets the display page to the measurement display page (MEASurement).

MSETup sets the display page to the measurement setup page (Meas SETup).

SSETup sets the display page to the system setup page (System SETup).

IFILE sets the display page to the internal file setup page (IFILE).

EFILE sets the display page to the external file setup page (EFILE).

ABOut sets the display page to the About page (ABOut).

For example: WrtCmd("DISP:PAGE MEAS"); set the display page to the measurement display page.

ⓘ NOTE: This command will be ignored in the phase of measurement.

Query syntax: DISPlay:PAGE?

Return format: <page name><NL^END>

<page name> are as follows:

- < MEAS DISP > indicates that the current displayed page is the measurement display page.
- < MEAS SETUP > indicates that the current displayed page is the measurement setup page.
- <SYSTEM SETUP> indicates that the current displayed page is the system setup page.
- < INT FILE > indicates that the current displayed page is the internal file page.
- < EXT FILE > indicates the current displayed page is the external file page.
- < IO SETUP > indicates that the current displayed page is the IO setup page.
- < ABOUT > indicates that the current displayed page is the About display page.

The :WAVE command sets the waveform display mode. The :WAVE? query returns the current waveform display mode.

Command syntax:

$$\text{DISPlay:WAVE} \left\{ \begin{array}{l} \text{AON} \\ \text{STD} \\ \text{TEST} \\ \text{AOFF} \end{array} \right\}$$

Where,

AON Both the standard waveform and the tested waveform are displayed on the screen.

STD Only the standard waveform is displayed on the screen.

TEST Only the tested waveform is displayed on the screen.

AOFF No waveform is displayed.

For example: WrtCmd("DISP:WAVE STD"); set to display the standard waveform only.

Query syntax: DISPlay:WAVE?

Return format: <WAVE STAT> <NL^END>

Where,

ALL ON Both the standard waveform and the tested waveform are currently displayed on the screen.

ONLY STDWAVE Only the standard waveform is currently displayed on the screen.

ONLY TESTWAVE Only the tested waveform is currently displayed on the screen.

ALL OFF No waveform is displayed on the screen.

The :GRID command sets the grid display mode. The :GRID? query returns the current grid display mode.

Command syntax:

$$\text{DISPlay:GRID} \left\{ \begin{array}{l} \text{ON} \\ \text{OFF} \end{array} \right\}$$

Where,

ON the grid display mode is ON.

OFF the grid display mode is OFF.

For example: WrtCmd("DISP:GRID ON"); the grid display mode is ON.

Query syntax: DISPlay:GRID?

Return format:

$$\left\{ \begin{array}{l} \text{OFF} \\ \text{ON} \end{array} \right\} \langle \text{NL}^{\wedge} \text{END} \rangle$$

Where,

Off means that the current grid display mode is OFF.

On means that the current grid display mode is ON.

The :MEASdisp command sets the steps to measure waveform display.

Command syntax:

DISPlay:MEASdisp UP Return to the last measurement waveform graph and result
DOWN Return to the next measurement waveform graph and result

For example: WrtCmd("DISP:MEASdisp UP"); Set to display the test result of the last step.

8.3.2 IVOLTage subsystem commands

The Impulse VOLTage subsystem commands set the impulse voltage, average times, impulse voltage auto adjust and delay, etc. Figure 8-3 shows the Impulse VOLTage subsystem command tree.

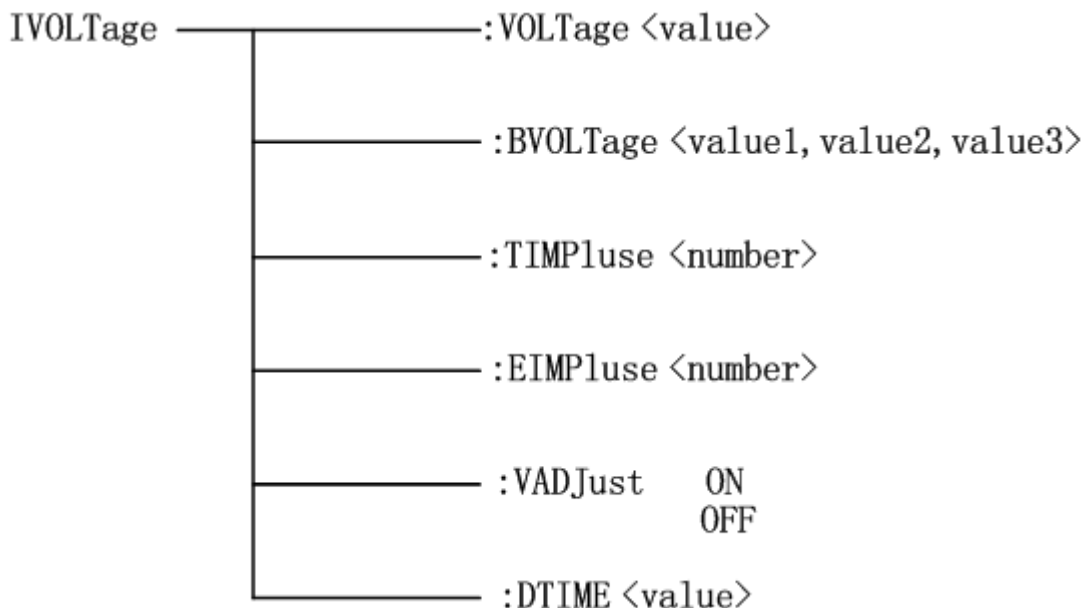

Figure 8-3 IVOLTage subsystem command tree

The [:VOLTage] command sets the impulse voltage for testing. The [:VOLTage]? query returns the current impulse voltage value.

Command syntax:

```
IVOLTage [:VOLTage] <value>
```

Where,

<value> can be NR1, NR2 or NR3 format followed by KV or V and the value must be between 100V to 5000V.

MIN Set the impulse voltage to 100V.

MAX Set the impulse voltage to 5000V.

For example: WrtCmd("IVOLT:VOLT 1000V"); set the impulse voltage to 1000V.

Query syntax: IVOLTage[:VOLTage]?

Return format: <NR1><NL^END>

The :BVOLTage command sets parameters for Break Test. The :BVOLTage? query returns the current voltage for Break Test.

Command syntax:

```
IVOLTage:BVOLTage <value1, value2, value3>
```

Where

<value1, value2, value3> can be NR1, NR2 or NR3 data format or parameters followed by KV, V suffix, the set pulse voltage value is between 100V-5000V, but the value of value1 must be greater than The value of value2; the value of value3 is between 1 and 50, representing the step percentage from value1 to value2.

For example: WrtCmd("IVOLT:BVOLT 1000V, 3000V, 4"); set the start voltage to 1000V, end voltage to 3000V and voltage step is 4%.

Query syntax: IVOLT:BVOLT?

Return format: <NR1>,<NR1>,<NR1><NL^END>

The :TIMPulse command sets the average times for testing. The :TIMPulse? query returns the current average times.

Command syntax: IVOLTage:TIMPulse <number>

Where,

<number> is NR1 format ranging from 1 to 32.

For example: WrtCmd("IVOLT: TIMPulse 3"); set the average times to 3.

Query syntax: IVOLTage:TIMPulse?

Return format: <NR1><NL^END>

The :EIMPulse command the times of erasing impulses for testing. The :EIMPulse? query returns the current times of erasing impulses.

Command syntax: IVOLTage: EIMPulse <number>

Where,

<number> is NR1 format ranging from 0 to 16.

For example: WrtCmd(“IVOLT: EIMPulse 3”); set the times to 3.

Query syntax: IVOLTage:EIMPulse?

Return format: <NR1><NL^END>

The :VADJust command sets the impulse auto adjust function to ON or OFF.

The :VADJust? query returns the current state of the impulse auto adjust function.

Command syntax:

	ON
IVOLTage:VADJust	OFF

Where,

ON When the function is ON

OFF When the function is OFF

For example: WrtCmd(“IVOLT:VADJ OFF”); turn off the voltage auto adjust function.

Query syntax: IVOLTage:VADJust?

Return format:

{	Off	}	<NL^END>
	On		

The :DTIME command sets the delay time between two tests in the INT test mode. The :DTIME? query returns the current delay time.

Command syntax: IVOLTage:DTIME <value>

Where,

<value> can be NR1, NR2 or NR3 format followed by s or ms. The set delay time ranges from 0.1s to 99.9s.

For example: WrtCmd(“IVOLT:DTIME 50.1s”); set the delay time to 50.1s.

Command syntax: IVOLTage:DTIME?

Return format: <NR3><NL^END>

8.3.3 SRATE subsystem commands

The Sample RATE subsystem commands set the sample rate and the time base zoom. Figure 8-4 shows the Sample RATE subsystem command tree.

SRATE ———— [:RATE] ———— <value>

Figure 8-4 Sample RATE subsystem command tree

The :RATE command sets the sample rate. The :RATE? query returns the current sample rate.

Command syntax: SRATE[:RATE] <value>

Where,

<value> The available values are listed as follows:

200msa/s(200m), 100msa/s, 50msa/s, 25msa/s, 12.5msa/s, 6.25msa/s,
3.12msa/s, 1.56msa/s

For example: WrtCmd("SRATE:RATE 100MSa/s"); 100MSa/s.

Command syntax: SRATE[:RATE]?

Return format: <NR2 Msa/s><NL^END>

8.3.4 COMParator subsystem commands

The COMParator subsystem commands set the compare conditions, such as Areasize, Diffzone, Corona and Phasediff. Figure 8-5 shows the command tree of the COMParator subsystem commands.

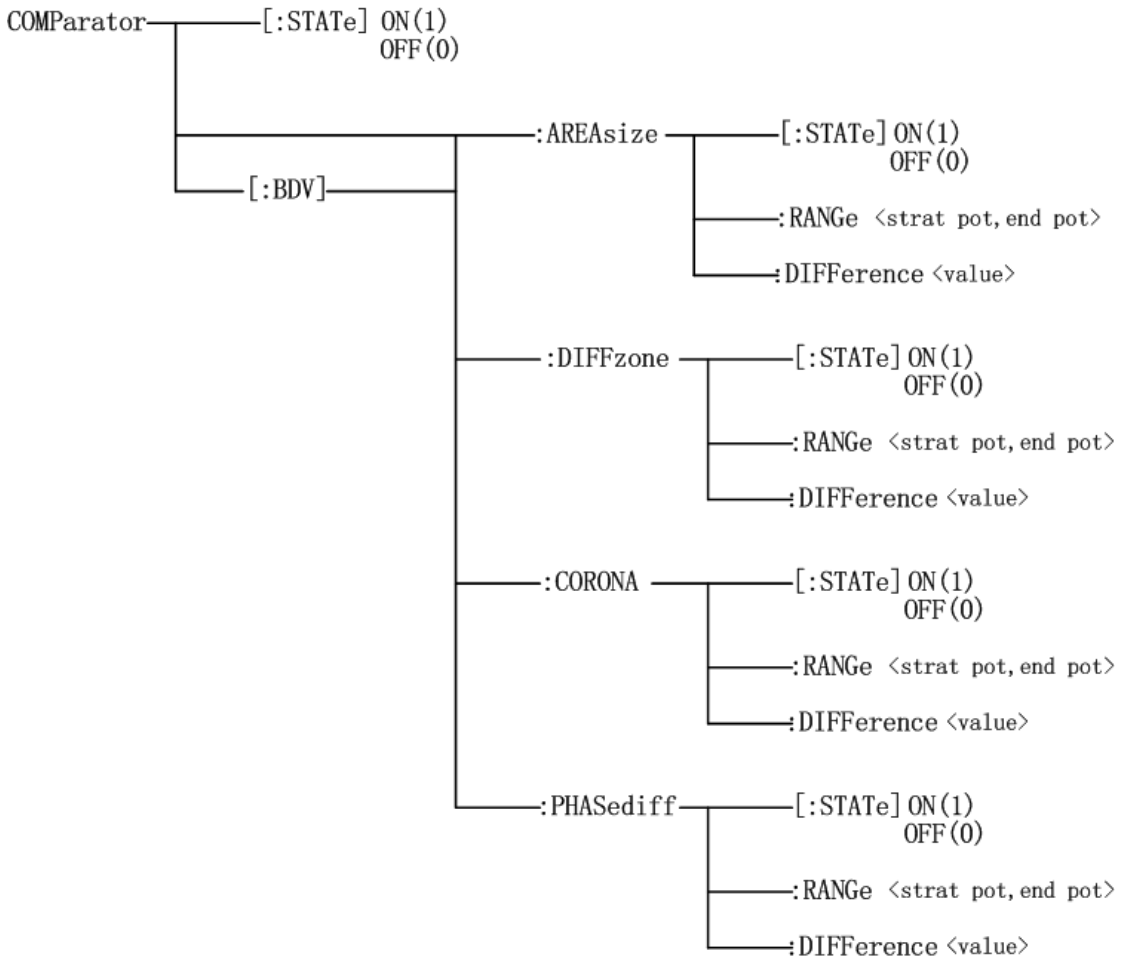

Figure 8-5 COMParator subsystem command tree

The BDV here stands for the destruction test, and its comparison setting method is the same as the non-destructive test, and will be merged when writing the command syntax and query syntax of the destructive test and the non-destructive test.

The [:STATe] command sets the comparator function to ON or OFF. The [:STATe]? query returns the current comparator state.

Command syntax:

$$\text{COMParator[:STATe]} \left\{ \begin{array}{c} \text{ON} \\ \text{OFF} \\ 1 \\ 0 \end{array} \right\}$$

Where,

1 (decimal49) is equal to ON; the comparator is ON.

0 (decimal48) is equal to OFF; the comparator is OFF.

For example: WrtCmd("COMP ON"); turn on the comparator function.

Query syntax: COMParator[:STATe]?

Return format: <COMP STAT><NL^END>

Where,

<COMP STAT> is ON to indicate that the comparison function is turned on.

OFF to indicate that the comparison function is turned off

The :AREAsize[:STATe] command sets the Areasize comparator function to ON or OFF.

The :AREAsize[:STATe]? query returns the current Areasize comparator state.

Command syntax:

$$\text{COMParator:AREAsize[:STATe]} \left\{ \begin{array}{c} \text{ON} \\ \text{OFF} \\ 1 \\ 0 \end{array} \right\}$$

$$\text{COMParator:BDV:AREAsize[:STATe]} \left\{ \begin{array}{c} \text{ON} \\ \text{OFF} \\ 1 \\ 0 \end{array} \right\}$$

For example: WrtCmd("COMP:AREA ON"); turn on the Areasize comparator function.

WrtCmd("COMP:BDV:AREA ON"); turn on the destruction test area comparison method.

Query syntax: COMParator:AREAsize[:STATe]?

COMParator:BDV:AREAsize[:STATe]?

Return format: <AREA STAT><NL^END>

<AREA STAT> is ON to indicate that the Areasize comparator function is turned on.

OFF to indicate that the Areasize comparator function is turned off

(The following BDV command will not be introduced separately; its syntax is to add a BDV in the grammar of non-destructive testing)

The :AREAsize:RANGe command sets the comparison range of Areasize comparator. The :AREAsize:RANGe? query returns the current comparison range of Areasize comparator.

Command syntax: COMPArator:AREAsize:RANGe <start pot>, <end pot>

Where,

<start pot> start point of comparison range. NR1 format, range from 0 to 6000, without unit.

<end pot> end point of comparison range. NR1 format, range from 0 to 6000, without unit.

For example: WrtCmd("COMP:AREA:RANG 0, 960 "); set the comparison range from 0 to 960.

ⓘ NOTE: The end point value should be larger than that of the start point; otherwise an error message will be displayed on the system message line.

Query syntax: COMP:AREA:RANG?

Return format: <start pot>, <end pot><NL^END>

start pot, end pot are NR1 format.

The :AREAsize:DIFFerence command sets the difference limit value of Areasize comparator. The :AREAsize:DIFFerence? query returns the current difference limit value of Areasize comparator.

Command syntax: COMPArator:AREAsize:DIFFerence <value>

Where

<value> can be NR1, NR2 or NR3 format without unit.

For example: WrtCmd("COMP:AREA:DIFF 2.5"); set the difference limit value to 2.5%.

ⓘ NOTE: The <value> here is a percent value, For example, input 2.5 for 2.5%.

Query syntax: COMPArator:AREAsize:DIFFerence?

Return format: <NR3><NL^END>

The :DIFFzone[:STATe] command sets the Diffzone comparator to ON or OFF. The :DIFFzone[:STATe]? query returns the current Diffzone comparator state.

Command syntax:

$$\text{COMPArator:DIFFzone[:STATe]} \left\{ \begin{array}{l} \text{ON} \\ \text{OFF} \\ 1 \\ 0 \end{array} \right\}$$

Where,

1 (decimal 49) When the function is ON

0 (decimal 48) When the function is OFF

For example: WrtCmd("COMP:DIFF ON"); turn on the Diffzone comparator.

Query syntax: COMPArator:DIFFzone[:STATe]?

Return format:

$$\left. \begin{array}{c} \text{Off} \\ \text{On} \end{array} \right\} \langle \text{NL}^{\wedge} \text{END} \rangle$$

The :DIFFzone:RANGe command sets the comparison range of the Diffzone comparator.

The :DIFFzone:RANGe? query returns the current comparison range of the Diffzone comparator.

Command syntax: COMPArator:DIFFzone:RANGe <start pot>, <end pot>

Where,

<start pot> start point of comparison range. NR1 format, range from 0 to 6000, without unit.

<end pot> end point of comparison range. NR1 format, range from 0 to 6000, without unit.

For example: WrtCmd(“COMP:DIFF:RANG 0,960 ”); set the comparison range from 0 to 960. ①

NOTE: The end point value should be larger than that of the start point; otherwise an error message will be displayed on the system message line.

Query syntax: COMP:DIFF:RANG?

Return format: <start pot>, <end pot><NL^END>

start pot, end pot are NR1 format.

The :DIFFzone:DIFFerence command sets the difference limit value of Diffzone comparator.

The :DIFFzone:DIFFerence? query returns the current difference limit value of the Diffzone comparator.

Command syntax: COMPArator:DIFFzone:DIFFerence <value>

Where,

<value> can be NR1, NR2 or NR3 format without unit.

For example: WrtCmd(“COMP:AREA:DIFF 2.5”); set the difference limit value to 2.5%.

① NOTE: Here <value> is a percent value, for example, input 2.5 for 2.5%.

Query syntax: COMPArator:DIFFzone:DIFFerence?

Return format: <NR3><NL^END>

The :COROna[:STATe] command sets the Corona comparator to ON or OFF.

The :COROna[:STATe]? query returns the current Corona comparator state.

Command syntax:

$$\text{COMPArator:COROna[:STATe]} \left\{ \begin{array}{c} \text{ON} \\ \text{OFF} \\ 1 \\ 0 \end{array} \right\}$$

Where,

1 (decimal 49) When the function is ON

0 (decimal 48) When the function is OFF

For example: WrtCmd("COMP:CORO ON"); turn on the Corona comparator.

Query syntax: COMPArator:COROna[:STATe]?

Return format:

$$\left\{ \begin{array}{c} \text{Off} \\ \\ \text{On} \end{array} \right\} \langle \text{NL}^{\wedge} \text{END} \rangle$$

The :COROna:RANGe command sets the comparison range of the Corona comparator.

The :COROna:RANGe? query returns the current comparison range of the Corona comparator.

Command syntax: COMPArator:COROna:RANGe <start pot>, <end pot>

Where,

<start pot> start point of comparison range. NR1 format, range from 0 to 6000, without unit.

<end pot> end point of comparison range. NR1 format, range from 0 to 6000, without unit.

For example: WrtCmd("COMP:CORO:RANG 100,200"); set the comparison range from 100 to 200.

ⓘ NOTE: The end point value should be larger than that of the start point; otherwise an error message will be displayed on the LCD screen.

Query syntax: COMP:CORO:RANG?

Return format: <start pot>, <end pot><NL^END> start pot, end pot are NR1 format.

The :COROna:DIFFerence command sets the difference limit value of the Corona comparator.

The :COROna:DIFFerence? query returns the current difference limit value of the Corona comparator.

Command syntax: COMPArator:COROna:DIFFerence <value>

Where,

<value> is NR1 format, range from 0 to 999 without unit.

For example: WrtCmd("COMP:CORO:DIFF 20"); set the difference value to 20.

Query syntax: COMPArator:COROna:DIFFerence?

Return format: <NR1><NL^END>

The :PHASediff[:STATe] command sets the Phasediff comparator to ON or OFF.

The :PHASediff[:STATe]? query returns the current Phasediff comparator state.

Command syntax:

$$\text{COMParator:PHASediff[:STATe]} \left\{ \begin{array}{l} \text{ON} \\ \text{OFF} \\ 1 \\ 0 \end{array} \right\}$$

Where,

1 (decimal 49) When the function is ON

0 (decimal 48) When the function is OFF

For example: WrtCmd("COMP:PHAS ON"); turn on the Phasediff comparator.

Query syntax: COMParator:PHASediff[:STATe]?

Return format:

$$\left\{ \begin{array}{l} \text{Off} \\ \text{On} \end{array} \right\} \langle \text{NL}^{\wedge} \text{END} \rangle$$

The :PHASediff:POSItion command sets which zero-crossing point is used in the Phasediff comparator. The :PHASediff:POSItion? query returns the zero-crossing position value of the Phasediff comparator.

Command syntax: COMParator:PHASediff:POSItion <value>

Where,

<value> Zero-crossing position value, NR1 format, range from 2 to 10 without unit.

For example: WrtCmd("COMP:PHAS:POS 3"); the third zero-crossing point is used.

Query syntax: COMP:PHAS:POS?

Return format: <NR1><NL^END>

The :PHASediff:DIFFerence command sets the difference limit value of the Phasediff comparator. The :PHASediff:DIFFerence? query returns the current difference limit value of the Phasediff comparator.

Command syntax: COMParator:PHASediff:DIFFerence <value>

Where,

<value> can be NR1, NR2 or NR3 format without unit.

For example: WrtCmd("COMP:PHAS:DIFF 2.5"); set the difference limit value to 2.5%.

ⓘ NOTE: Here <value> is a percent value, for example, input 2.5 for 2.5%.

Query syntax: COMParator:PHASediff:DIFFerence?

Return format: <NR3><NL^END>

8.3.5 TRIGger subsystem commands

The TRIGger subsystem command group is used to trigger a measurement or to set the trigger mode. Figure 8-6 shows the TRIGger subsystem command tree.

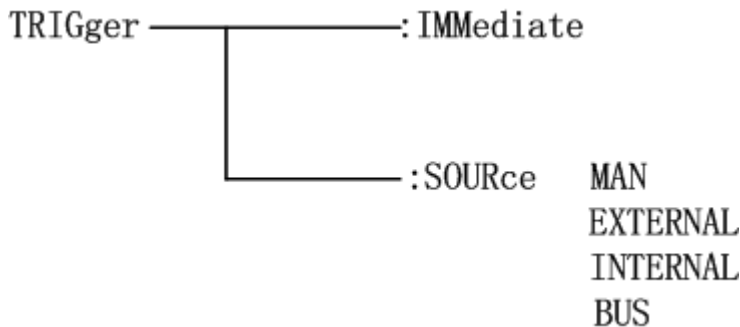

Figure 8-6 TRIGger subsystem command tree

The [:IMMediate] command triggers a measurement.

Command syntax: TRIGger[:IMMediate]

For example: WrtCmd("TRIG");

ⓘ NOTE: The TRIGger[:IMMediate] command, available only in the <MEAS DISP> page, will be ignored when TH2883 is in the testing state. The trigger mode must be set to BUS mode, or this command will be ignored. This command is only used to trigger the test of DUT. Refer to Standard WAVE subsystem commands for the details of triggering standard waveform test.

The :SOURce command sets the trigger mode. The :SOURce? query returns the current trigger mode.

Command syntax:

$$\text{TRIGger:SOURce} \left\{ \begin{array}{l} \text{MAN} \\ \text{EXternal} \\ \text{INTernal} \\ \text{BUS} \end{array} \right\}$$

Where,

MAN Triggered by pressing the **START** button or using foot control switch

EXternal Triggered by the HANDLER interface.

INTernal Automatically triggered after pressing the **START** button.

BUS Triggered by RS232 interface, USB or LAN interface.

For example: WrtCmd("TRIG:SOUR BUS"); set to bus mode.

Query syntax: TRIGger:SOURce?

Return format:

$$\left. \begin{array}{l} \text{Man} \\ \text{Int} \\ \text{Ext} \\ \text{Bus} \end{array} \right\} \langle \text{NL}^{\wedge} \text{END} \rangle$$

8.3.6 STATistic subsystem commands

The STATistic subsystem commands set the statistic function to ON or OFF, clear or save statistic data. Figure 8-9 shows the STATistic subsystem command tree.

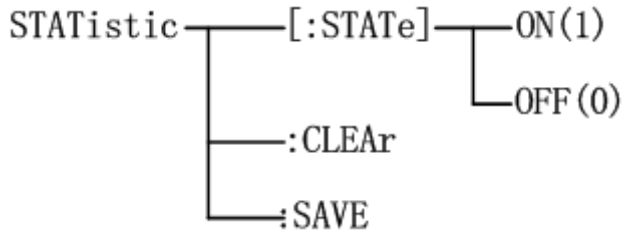

Figure 8-7 STATistic subsystem command tree

The [:STATe] command sets the statistic function to ON or OFF. The [:STATe]? query returns the current state of the statistic function.

Command syntax:

$$\text{STATistic[:STATe]} \left\{ \begin{array}{l} \text{ON} \\ \text{OFF} \\ 1 \\ 0 \end{array} \right\}$$

Where,

1 (decimal 49) When the function is ON

0 (decimal 48) When the function is OFF

For example: WrtCmd("STAT ON"); turn on the statistic function.

Query syntax: STATistic[:STATe]?

Return format: <NR1><NL^END>

The :CLEAR command is used to clear the statistic data.

Command syntax: STATistic:CLEAR

The :SAVE command is used to save the statistic data to a file.

Command syntax: STATistic:SAVE

8.3.7 WADJust subsystem commands

The WADJust subsystem command is mainly used to display the time base transformation of the output waveform and the left and right movement of the waveform. Figure 8-8 shows the WADJust subsystem command tree.

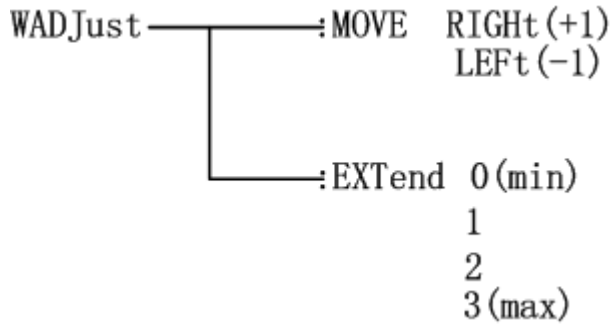

Figure 8-8 WADJust subsystem command tree

The [:MOVE] command is used for the waveform movement.

Command syntax:

```

WADJust:MOVE      RIGHT
                  LEFT
  
```

Where, RIGHt is right shift of the waveform.

LEFt is left shift of the waveform.

For example: WrtCmd("WADJust:MOVE +1"); Waveform right shift

Or WrtCmd("WADJust:MOVE RIGHt"); Waveform right shift

The [:EXTend] command is used for time base scaling for the waveform. The [:EXTend]? query returns the time base scaling of the waveform.

Command syntax: WADJust:EXTend 1

For example: WrtCmd("WADJust: EXTend 0"); The waveform displayed at this time is the most.

Or WrtCmd("WADJust: EXTend min"); The waveform displayed at this time is the most.

Query syntax: WADJust:EXTend?

Return format: <NR1><NL^END>

8.3.8 SWAVE subsystem commands

The Standard WAVE subsystem commands set the parameters for sampling the standard waveform, including setting the standard waveform sample mode, triggering the measurement of a standard waveform and choosing a sampled standard waveform. Figure 8-9 shows the Standard WAVE subsystem command tree.

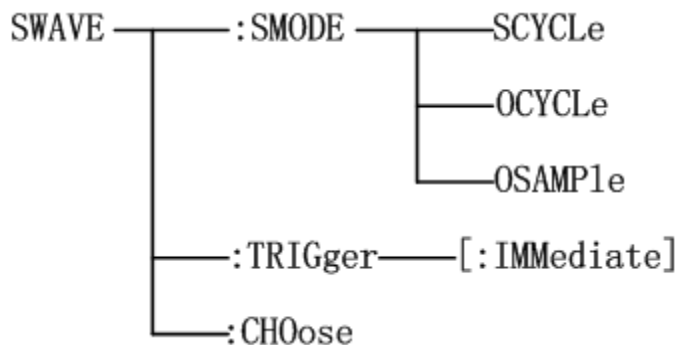

Figure 8-9 Standard WAVE subsystem command tree

The :SMODE command sets the sample mode of the standard waveform. The :SMODE? query returns the current sample mode.

Command syntax:

$$\text{SWAVE:SMODE} \left\{ \begin{array}{l} \text{SCYCLe} \\ \text{OCYCLe} \\ \text{OSAMPle} \end{array} \right\}$$

Where,

SCYCLe Set the standard waveform sample mode to sequential-cycle.

OCYCLe Set the standard waveform sample mode to one-cycle.

OSAMPle Set the standard waveform sample mode to one-sample.

For example: WrtCmd("SWAVE:SMODE OSAMPle"); set the standard waveform sample mode to one-sample.

Query syntax: SWAVE:SMODE?

Return format:

$$\left\{ \begin{array}{l} \text{SEQ CYCLE} \\ \text{ONE CYCLE} \\ \text{ONE SAMPLE} \end{array} \right\} \langle \text{NL}^{\wedge} \text{END} \rangle$$

Where: SEQ CYCLE is sequence-cycle mode, ONE CYCLE is one-cycle mode, ONE SAMPLE is one-sample mode.

The :TRIGger[:IMMediate] command is used to trigger a standard waveform measurement.

Command syntax: SWAVE:TRIGger[:IMMediate]

For example: WrtCmd("SWAVE:TRIG");

① NOTE: 1. This command is available only on the <MEAS DISP> page.

2. This command will be ignored if the trigger mode is not set to BUS mode.

3. This command will be ignored when TH2883 is in testing state.

The :CHOose command is used to select the required standard waveform.

Command syntax: SWAVE:CHOose

For example: WrtCmd("SWAVE:CHO");

NOTE: 1. This command is available only on <MEAS DISP> page.

2. This command is valid only when sampling test is finished in SEQ CYCLE mode or ONE CYCLE mode.

8.3.9 FETCh? subsystem commands

The FETCh? subsystem commands are used to output waveform data, comparison results and including the output voltage, frequency and time measurement result. Figure 8-10 shows the FETCh? subsystem command tree.

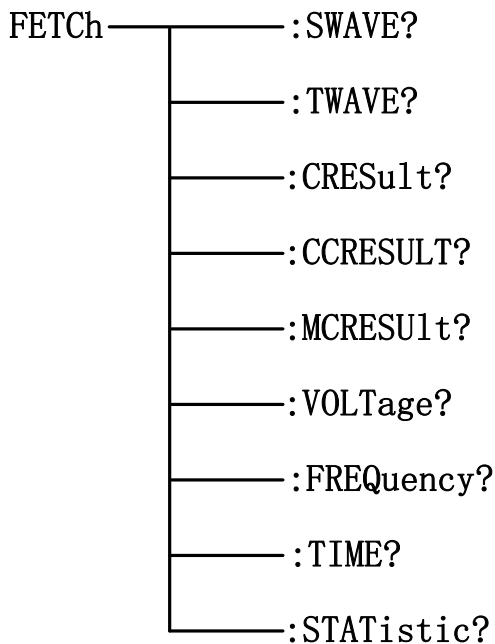

Figure 8-10 FETCh? subsystem command tree

The :SWAVE? query outputs the current standard waveform data.

Query syntax: FETCh:SWAVE?

For example: WrtCmd("FETC:SWAVE?");

The :TWAVE? Query outputs the latest tested waveform data.

Query syntax: FETCh:TWAVE?

For example: WrtCmd("FETC:TWAVE?");

NOTE:

If the waveform data is not ready, the FETCh SWAVE? and FETCh TWAVE? query will be executed after the current measurement or next measurement is finished.

The :CCRESULT? query output the total judgment result of the device under test.

Query syntax: FETCh:CCRESULT?

Return format: <NR1> <NL^END>

NR1 is 1, or 0

1 stands for PASS and 0 stands for FAIL.

The :CRESt? query returns the latest comparison result.

Query syntax: FETCh:CRESt?

Return format: There are three cases as follows:

1. If the comparator function or four comparison methods is set to OFF, the query response will be <NR1><NL^END>, here NR1 is 2.
2. If there is no waveform data available, the return format will be <NR1><NL^END>, here NR1 is 3.
3. If the comparator function is set to on, the return format will be <NR1, NR3, NR3, NR1, NR3><NL^END>, the first NR1 is the general comparison result: 1 (PASS) or 0 (FAIL). The following four data are the comparison results corresponding to each comparator: AREA SIZE, DIFF ZONE, CORONA and PHASE DIFF.

①NOTE: TH2883 returns the comparison result when the comparator is turned on. TH2883 returns 9.9E37 when the AREA SIZE, DIFF ZONE or PHASE DIFF comparator is turned off. TH2883 returns 9999 when the CORONA comparator is turned off.

The :MCRESult? query returns the judgment result of each step of the test piece.

Query syntax: FETCh:MCRESult?

Return format: There are three cases as follows:

1. If the comparator function or four comparison methods is set to OFF, the query response will be <NR1><NL^END>, here NR1 is 2.
2. If there is no waveform data available, the return format will be <NR1><NL^END>, here NR1 is 3.
3. If the comparator function is set to on, the return format will be <NR1, NR3, NR3, NR1, NR3><NL^END>, the first NR1 is the general comparison result: 1 (PASS) or 0 (FAIL). The following four data are the comparison results corresponding to each comparator: AREA SIZE, DIFF ZONE, CORONA and PHASE DIFF.

NOTE: TH2883 returns the comparison result when the comparator is turned on. TH2883 returns 9.9E37 when the AREA SIZE, DIFF ZONE or PHASE DIFF comparator is turned off. TH2883 returns 9999 when the CORONA comparator is turned off.

The :VOLTage? query returns the current voltage value in the set voltage range. Refer to MEASure subsystem commands for the voltage range settings.

Query syntax: FETCh:VOLTage?

Return format: <NR1><NL^END>

NOTE: The unit of the returned voltage is V.

The :FREQuency? query returns the current frequency result in the set frequency range. Refer to MEASure subsystem commands for the frequency range settings.

Query syntax: FETCh:FREQuency?

Return format: <NR3><NL^END>

NOTE: The unit of the returned frequency is Hz. If the start point is overlapped with the end cursor completely, then 9.9E37 will be returned.

The :TIME? query returns the current time result in the set time range. Refer to MEASure subsystem commands for the time range settings.

Query syntax: FETCh:TIME?

Return format: <NR3><NL^END>

NOTE: The unit of the returned time is s.

The :STATistic? query returns the current statistic result.

Query syntax: FETCh:STATistic?

Return format: <NR1>, <NR1>, <NR1>, <NR1>, <NR1>, <NR1>, <NR1>, <NR1>, <NR1>, <NR1>, <NL^END>

The returned data are in turn as follows: total test times and times of PASS, total test times for Area Size comparison and times of PASS, total test times for Diff Zone comparison and times of PASS, total test times for Corona comparison and times of PASS, total times for Phase Diff comparison and times of PASS. PASS rate can be automatically calculated according to the returned data.

8.3.10 MEASure subsystem commands

The MEASure subsystem commands sets the measurement range of voltage, frequency and time. Figure 8-11 shows the MEASure subsystem command tree.

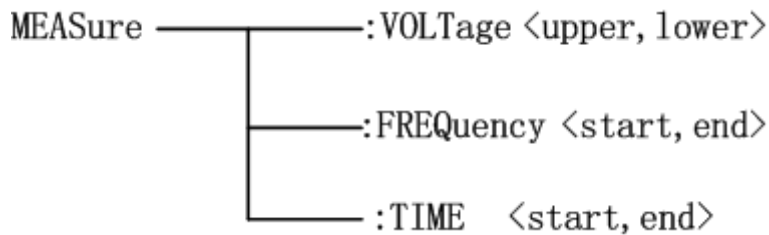

Figure 8-11 MEASure subsystem command tree

The :VOLTage command sets the measurement range of voltage. The :VOLTage? query returns the current voltage range.

Command syntax: MEASure:VOLTage <upper>,<lower>

Where,

<upper> is the upper limit of voltage, NR1 format, ranging from 1 to 248 without unit.

<lower> is the lower limit of the voltage, NR1 format, ranging from 1 to 248 without unit.

For example: WrtCmd("MEAS:VOLT 1,199"); set the voltage to range from 1 to 199.

NOTE: The lower limit must be less than the upper one; otherwise an error message will be displayed on the system message line.

Query syntax: MEASure:VOLTage?

Return format: <upper, lower><NL^END>

Both upper limit and lower limit are NR1 format.

The :FREQuency command sets the frequency range. The :FREQuency? query returns the currently set frequency range.

Command syntax: MEASure:FREQuency <start, end>

Where,

<start> is the start point of frequency, NR1 format and ranging from 1 to 598 without unit.

<end> is the end point of frequency, NR1 format and ranging from 1 to 598 without unit.

For example: WrtCmd("MAES:FREQ 100,200"); set the frequency to range from 100 to 200.

NOTE: The value of the end point must be larger than that of the start point; otherwise an error message will be displayed on the system message line.

NOTE: The measurement ranges of frequency and time are the same, thus the time range will vary with the frequency range.

Query syntax: MEASure:FREQuency?

Return format: <start, end><NL^END>

Both <start> and <end > are NR1 format.

The :TIME command sets the time range. The :TIME? query returns the current time range.

Command syntax: MEASure:TIME<start, end>

Where,

<start> is the start point of time, NR1 format and ranging from 1 to 598 without unit.

<end> is the end point of time, NR1 format and ranging from 1 to 598 without unit.

For example: WrtCmd("MAES:TIME 100,200"); set the time to range from 100 to 200.

ⓘ NOTE: The value of the end point must be larger than that of the start point; otherwise an error message will be displayed on the system message line.

⚠ NOTE: The measurement ranges of frequency and time are the same, thus the time range will vary with the frequency range.

Query syntax: MEASure:TIME?

Return format: <start, end><NL^END>

Both <start> and <end> are NR1 format.

8.3.11 ABORt subsystem command

TH2883 will abort the current measurement as soon as the ABORt command is received.

Command syntax: ABORt

For example: WrtCmd("ABOR");

8.3.12 Mass MEMOrY subsystem commands

The Mass MEMOrY subsystem commands load and store files. Figure 8-12 shows the Mass MEMOrY subsystem command tree.

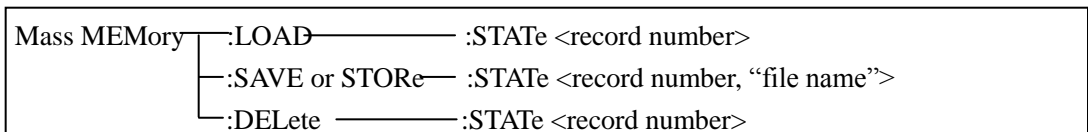

Figure 8-12 Mass MEMOrY subsystem command tree.

The :LOAD:STATe command is used to load the stored file.

Command syntax: MMEMory:LOAD:STATe <record number>

Where,

<record number> is the file serial number ranging from 1 to 60 without unit.

For example: WrtCmd("MMEM:LOAD:STAT 1"); load file 1.

ⓘ NOTE: 1. If the file you want to load is not available, "File not exist" message will be displayed on the system message line.

2. If the input file number is out of 1 to 60, message "Out of file range" will be displayed on the system message line.

⚠ NOTE: The file contains the page information. When a file is loaded, TH2883 will display

the saved page.

The :SAVE:STATE or STORE:STATE command is used to save the current setting data to a file.

Command syntax: MMEMory:STORE:STATE <record number, "filename">

Where,

<record number> is the file serial number ranging from 1 to 100 , NR1 format without unit.

<"filename"> The file name consists of less than 10 ASCII characters. <Unnamed> will be the default name, if you don't input a file name.

For example: WrtCmd("MMEM:STOR:STAT 1, "#TH2883*");

NOTE:

The file name assigned by bus will be quoted without any change, thus user can enter some special characters such as special symbols and letters in lower case that cannot be input on the panel of the instrument.

The :DELEte:STATE command deletes a file.

Command syntax: MMEMory:DELEte:STATE <record number>

Where,

<record number> is the file serial number ranging form 1 to 100, NR1 format without unit.

For example: WrtCmd("MMEM:DEL:STAT 1"); delete file 1.

NOTE: TH2883 will not give a warning message when a file is to be deleted.

8.3.13 MeasSTEP subsystem commands

The MeasSTEP subsystem commands are used for the selection of test step, test mode and channel state. Figure 8-13 shows the MeasSTEP subsystem command tree.

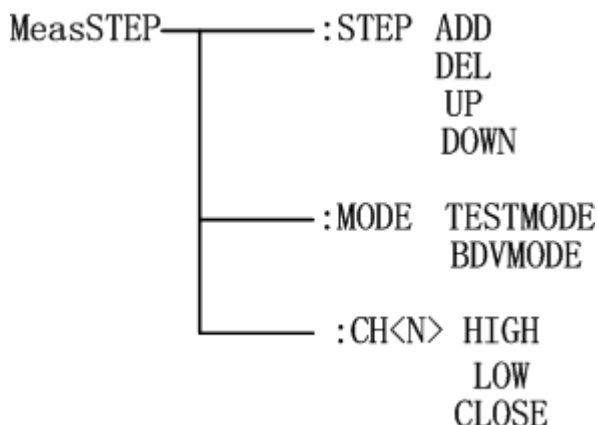

Figure 8-13 MeasSTEP subsystem command tree

The :STEP command is used to set the test step; the :STEP? command is used to query the current

test step.

Command syntax: MeasSTEP: STEP<setup>

<setup> is as follows:

ADD	adds a test step
DEL	reduces one test step
UP	returns to the previous test step
DOWN	returns to the next test step

For example: WrtCmd ("MeasSTEP:STEPADD"); add a test step.

Query syntax: MeasSTEP:STEP ?

The query returns: <NR1><NL^END>

<NR1> represents the current test step number.

The :MODE command is used to set the test mode; the :MODE? command is used to query the current test mode.

Command syntax: MeasSTEP: MODE<mode>

<mode> is as follows:

TESTMODE	Normal test mode
BDVMODE	Destructive test mode

For example: WrtCmd ("MeasSTEP:MODETESTMODE"); set the test mode to normal test mode.

Query syntax: MeasSTEP: STEP ?

The query returns: <NR1><NL^END>

<NR1> represents the current test step mode, with 0 representing TESTMODE and 1 representing BDVTEST.

The :CH<N> command is used to set the channel status. The :CH<N>? command is used to query the status of the current channel.

Command syntax: MeasSTEP:CH<N><status>

<status> is as follows:

HIGH	sets the channel to test high end
LOW	sets the channel to test the low end
CLOSE	set channel off

For example: WrtCmd ("MeasSTEP: CH1HIGH"); set CH1 to test high end.

Query syntax: MeasSTEP:CH<N> ?

The query returns: <status><NL^END>

<status> is as follows:

HIGH	indicates that this channel is the test high end
LOW	means this channel is the low end of the test
CLOSE	indicates that this channel is closed for testing

8.3.14 WaveSTEP subsystem commands

WaveSTEP subsystem commands are used for waveform settings such as standard waveforms, standard wave copying, and comparison tests. Figure 8-14 shows the WaveSTEP subsystem command tree.

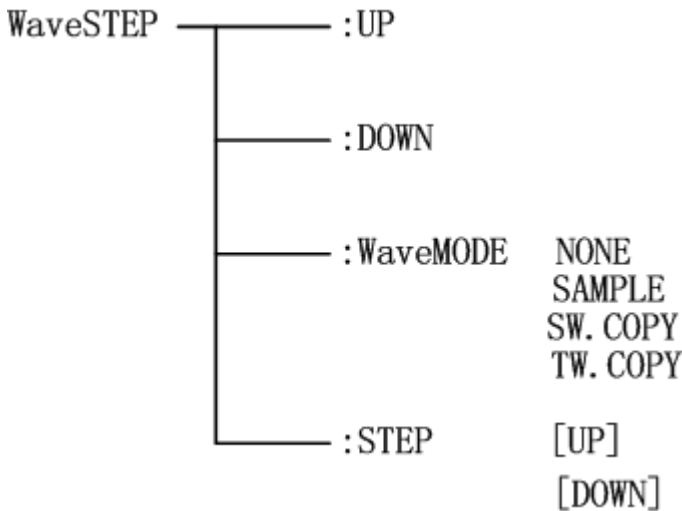

Figure 8-14 WaveSTEP subsystem command tree

The :UP command is used for the setting of the waveform step.

Command syntax: WaveSTEP:UP Returns to the previous step

For example: WrtCmd("WaveSTEP:UP"); returns to the previous waveform setup step.

The :DOWN command is used to set the waveform step.

Command syntax: WaveSTEP:DOWN Returns to the next step

For example: WrtCmd ("WaveSTEP: DOWN"); returns to the next waveform setup step.

The :WaveMODE command is used for waveform mode setting of this step; the :WaveMODE? command queries the waveform mode of this step.

Command syntax: WaveSTEP: WaveMODE <mode>

<mode> is as follows:

NONE this step does not have any settings

SAMPLE indicates that this step can perform standard wave sampling

SW.COPY indicates that the target wave of this step is copied to other steps

TW.COPY indicates that this step is a comparison test

For example: WrtCmd ("WaveSTEP: WaveMODESAMPLE"); set this step to enable standard wave sampling.

Query syntax: WaveSTEP: WaveMODE ?

The query returns: <mode><NL^END>

<mode> is as follows: NONE	This step does not have any settings
SAMPLE	This step is the standard wave sampling mode.
SW.COPY	This step is the standard wave copy mode.
TW.COPY	This step is a comparison test mode

The :STEP command is used for step copying or comparison test step selection; the :STEP? command queries the step in Standard Copy or Contrast Test.

Command syntax: WaveSTEP:STEP [stepdirection]

[stepdirection] is as follows:

UP If the mode is a standard copy or comparison test, it means that the previous step matches, and the other modes cannot use UP.

DOWN If the mode is a standard copy or comparison test, it means matching to the next step. Other modes cannot use DOWN.

For example: WrtCmd("WaveSTEP:STEPUP"); returns the previous step of copying or comparing the standard.

Query syntax: WaveSTEP: WaveMODE ?

The query returns: <step><NL^END>

<step> is as follows: STD.Step_XX	Standard copy copy step number.
TST.Step_XX	Compare test step numbers.

Note: XX in STD.Step_XX represents the step number.

8.3.15 Common commands

TH2883 provides following common commands:

*RST

The *RST command is used to reset the instrument.

Command syntax: *RST

For example: WrtCmd("*RST");

*TRG

The *TRG command (trigger command) triggers a measurement and writes the tested waveform data into the output buffer. This command is equal to TRIG+FETCh TWAVE? command.

Command syntax: *TRG?

For example: WrtCmd("*TRG?");

ⓘNOTE: This command is only available on the <MEAS DISP> pages. This command will also be ignored when TH2883 is in the testing state. This command is only used to trigger a measurement except for sampling a standard waveform. Refer to Standard WAVE Subsystem

commands for standard waveform test.***IDN?**

The *IDN? query returns the TH2883's ID information.

Query syntax: *IDN?

Return format: <product>,<version>,<NL^END>

Where,

<product> TH2883-5 Impulse Winding Tester

<version> software version number

8.4 Error and warning message

The bus commands may have some spelling errors, syntax errors or wrong parameters. TH2883 executes a command after the command is analyzed. If one of above errors occurs, TH2883 halts the command analysis, and the rest commands will be ignored. If a command (for example a trigger command is ignored.) is ignored, the rest commands will be executed. The error and warning messages will be displayed on the system message line.

The following table shows the common error and warning messages, which will be displayed on the message line when they occur.

Error message	Description
Unknown message!	Unknown command is received. Usually there is a spelling error in the command. For example: TRG should be TRIG DISP:PAG MEAS should be DISP:PAGE MEAS
Data out of range!	The data is out of range. For example: COMPArator: DIFFzone: RANGe <start pot, end pot> If start pot>end pot, it will report this error.
Error parameter!	Unrecognizable parameter is used. For example: TRIG:SOUR INTER, INTER is not the correct short-form and should not used.
Error unit suffix!	Units are unrecognizable, or the units are not correct. For example: IVOLT:DEL 200us, us can not be the unit of the impulse voltage.
Data too long!	Data is too long. For example: The number of characters for a file name can not exceed 12 characters and numeric parameter, 10 characters.
File not exist!	Load a file that is not available.
Out of file range!	Data exceeds file number range For example: WrtCmd ("MMEM:STOR:STAT 105,"#TH2883*") 105 is beyond the range of the file serial number, and the maximum

	value is 100.
Trigger ignores!	When TH2883 is in the testing state, all trigger signals will be ignored.
Command ignores!	Some command may be ignored. For example: DISP:PAGE MSET When TH2883 is in the testing state, this command will be ignored.
Error syntax!	Grammatical errors For example: WrtCmd ("MMEM:STOR:STAT 105,"#TH2883*") The file name #TH2883* without "" will report this error.
File already exist!	The file already exists, indicating that the file name to be saved has been duplicated.

Chapter 9 Handler interface

9.1 Basic information

The handler interface employs a 9-pin DB connector. Pin sequence is as follow.

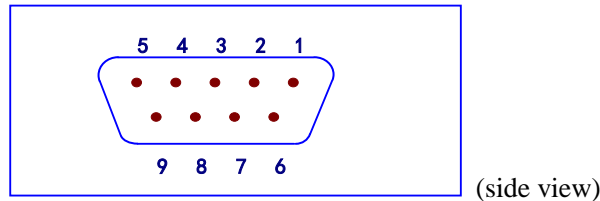

The signal definitions for each pin are described as follows:

①Note: The / (back slash) in the signal name means that the signal is asserted when low level

PIN ① EXGND: Common for external voltage source EXV.

When TH2883 series uses the internal voltage as the power supply for handler interface, TH2883 series' circuit common will be connected to EXTEND.

PIN ② /EOC: End of conversion.

/EOC signal is asserted when the A/D conversion is completed and TH2883 series is ready for the next DUT to be connected to the test terminals. The measurement data, however, is not valid until BUSY is asserted to low.

PIN ③ BUSY: TH2883 series is in the test state. When calculation, comparison and display are all completed, this signal is asserted to low.

PIN ④ /PASS: Pass signal output.

PIN ⑤ /FAIL: Fail signal output.

PIN ⑥ EXV: External DC voltage

DC voltage supply pins for DC isolated collector outputs, /EOC, /START, /STOP, /PASS, /FAIL, /EOM. The setting of internal jumpers must be changed when using the internal voltage supply.

PIN ⑦ /START: External trigger signal.

TH2883 series is triggered bon the rising edge of a pulse applied to this pin when the trigger mode is set to EXT mode.

PIN ⑧ /STOP: External stop signal

Test is interrupted on the rising edge of a pulse applied to this pin.

PIN ⑨ VCC: Internal voltage source supply (+5V)

Internal source is not recommended for user to use. Make sure the current is lower than 0.1 A and keep the signal line be away form interference source

when use.

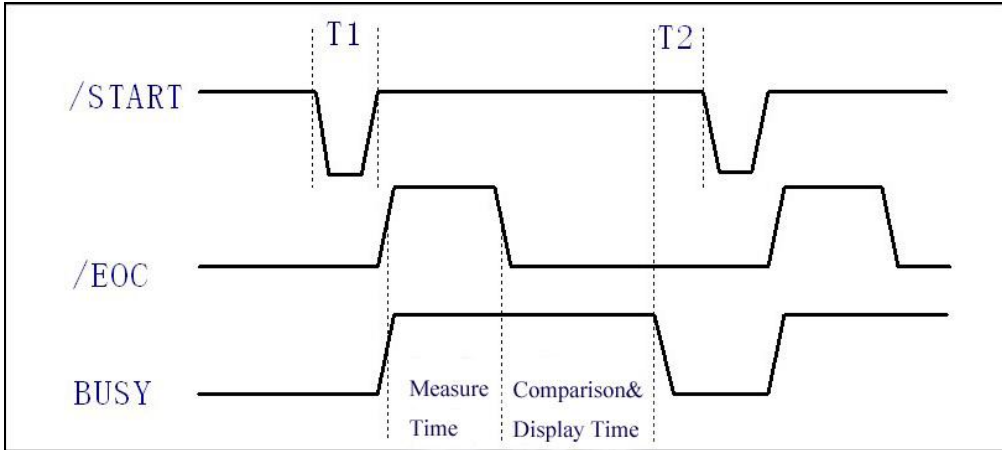

The timing diagram for handler interface is displayed in above figure, T1 is the trigger pulse width and the minimum pulse width is 1 us. T2 is the delay time, after the foregoing measurement completed to next trigger signal; its minimum pulse width is 0 us. /PASS and /FAIL signals are asserted after the measurement completed, till next trigger. The request of the /STOP pulse signal is the same as /START pulse signal.

9.2 Electrical characteristics

9.2.1 DC isolated output

Each DC output (pins 2 through 5) is the collector output of the built-in pull-up resistor and isolated by an opto-coupler. The output voltage of each line is set by a pull-up resistor on the handler interface board. The pull-up resistors can be connected to the internally supplied voltage (+5V), or to an externally applied voltage (EXV: +5V to +24V) by setting jumpers. Table 9-1 shows the electrical characteristics of the DC isolated outputs.

Output signal	Voltage output rating		Maximum current	Circuit common
	Low	High		
/EOC BUSY /PASS /FAIL	≤0.5V	+5V~ +24V	6mA	Internal pull-up voltage: TH2883 series circuit common GND External voltage (EXV): EXGND

Table 9-1 DC isolated output electrical characteristics

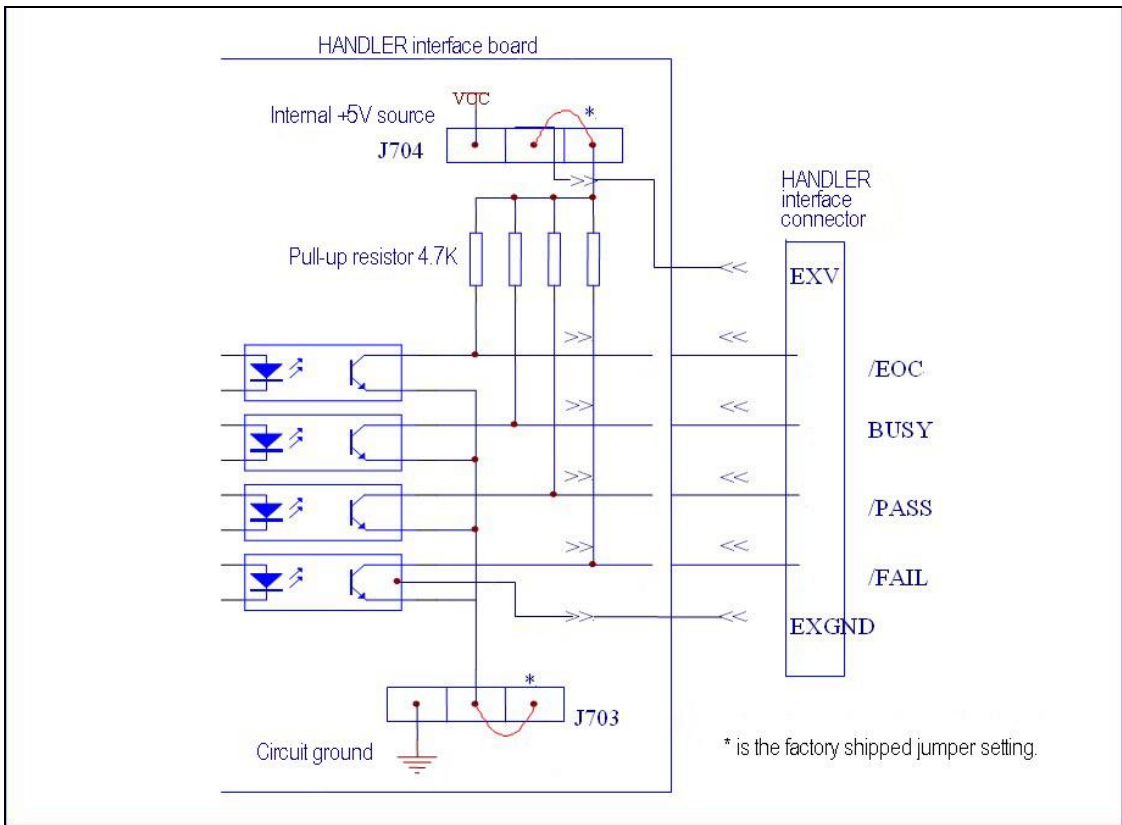

Figure 9-1 Simplified diagram of the output signals

A simplified diagram of the output signals is shown in Figure 9-1. * is the default jumper setting when shipped from factory. That is to say, the default jumper setting is to use external voltage source.

Refer to the next section Jumper Setup.

9.2.2 Isolated input

The /START signal (pin 7) and the /STOP signal (pin 8) are connected to the cathode of the LED in an opto-coupler. TH2883 series is triggered on the rising edge of the /START pulse and stopped on the rising edge of the /STOP pulse. The anode of the LED can be connected to the internal +5V, or an external voltage source EXV (the same external voltage source used for output signal).

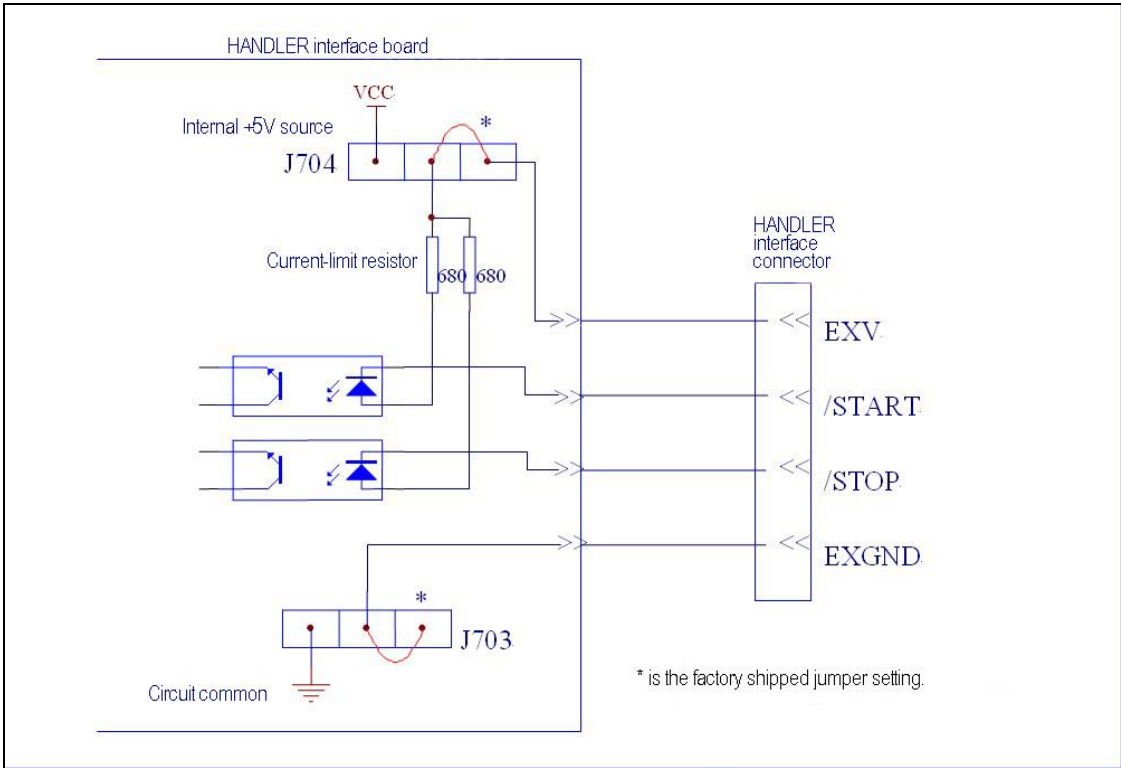

Figure 9-2 Simplified diagram of the input signal

In figure 9-2, the default jumper setting is to use external voltage source. Actually, the input signals and the output signals use the external voltage source together. The Current-limit resistor is used to limit the current and the default resistor is only suitable for external voltage source range from 5V to 8V. If the external voltage source is higher than 8V, you should replace the Current-limit resistor to avoid damaging circuit components. Current-limit resistor R705 and R706 should be both replaced. The detailed replacement information about Current-limit resistor is listed in table 9-2.

Current-limit resistor	Range of external voltage source
680Ω	5V to 8V
1.2KΩ	8V to 15V
2.2KΩ	15V to 24V

Table 9-2 Current-limit resistor for different voltage

9.3 Jumper setup on HANDLER interface

There are two jumpers on the Handler interface board. The two jumpers are used to select the internal voltage source for external voltage source for the output signal and input signal. Their locations are shown in figure 9-3.

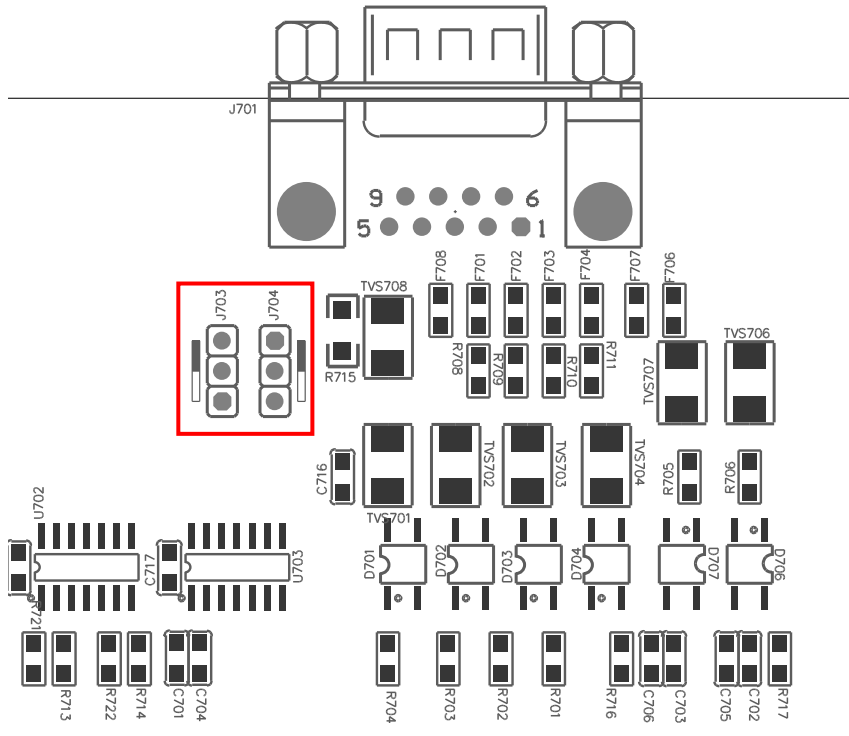

Figure 9-3 Jumper position on the Handler interface board

As above figure shown, when shipped from the factory, both jumpers are set at the upper position. If you want to apply the internal power supply, you must set both jumpers at the lower position. Likewise, when using external power supply to substitute the internal power supply, the two jumpers should be set at the same time.

ⓘ Warning: Make sure the instrument has been powered off and the plug has been removed before opening the case to alter jumper setting.

Chapter 10 Package contents and warranty

10.1 Package contents

Following items should be contained in the package.

Serial number	Name	Quantity
1	TH2883S8-5/S4-5 Impulse Winding Tester	1
2	TH2883-01 High-voltage Test clip leads	1
3	TH2881-001 Foot Switch	1
4	Three-wire power line	1
5	Fuse of 1A	2
6	Operational Manual	1
7	Manufacturer Certificate	1
8	Test Report	1
9	Warranty Card	1

Verify that you have received all above items and any optional accessories you may have ordered. If any one is missing, please contact us without delay.

10.2 Warranty

This Tonghui instrument product is warranted against defects in material and workmanship for a period of two years from the date of shipment. You should supply us with the warranty card before you enjoy the free maintenance service. This warranty does not apply in the event of misuse or abuse of the product or as a result of unauthorized alterations or repairs. Tonghui will, without charge, repair or replace, at its option, defective product or component parts.

The maintenance for this instrument should be performed by professional maintenance personnel. Do not substitute the internal components unauthorized when maintaining. In order to ensure the measurement accuracy, the instrument must be measured and corrected after maintenance. You should bear the maintenance expense for damages caused by unauthorized repairing or substituting components.

The instrument should not be placed in the environment present direct sunlight and moisture.

Place the instrument in the original package box if you do not use it for a long time.