

OPERATION MANUAL

TH2689/TH2689A

Capacitor Leakage Current/IR Meter

Tonghui Electronic Co. , Ltd.

Add: No.3,Tianshan Road,New District

Changzhou, China

TEL: (0519) 85132222, 85113342

FAX: (0519) 85109972

EMAIL: *sales@tonghui.com.cn*

Http://*www.tonghui.com.cn*

Content

CHAPTER 1 INTRODUCTION.....	2-1
1.1 INTRODUCTION	2-1
1.2 CONDITION	2-1
1.2.1 POWER ⚡	2-1
1.2.2 ENVIRONMENTAL TEMPERATURE AND HUMIDITY	2-1
1.2.3 WARM-UP	2-2
1.2.4 CAUTION ⚠	2-2
5.1 DIMENSION AND WEIGHT	5-2
5.2 SAFETY	5-2
5.2.1 INSULATED RESISTANCE	5-2
5.2.2 INSULATION INTENSITY	5-3
5.2.3 LEAKAGE CURRENT	5-3
5.3 ELECTROMAGNETIC COMPATIBILITY	5-3
CHAPTER 2 INSTRUCTION OF FRONT PANEL.....	4
2.1 INSTRUCTION OF FRONT PANEL.....	4
2.2 INSTRUCTION OF REAR PANEL.....	5
CHAPTER 3 OPERATION	7
3.1 CONNECTION OF (DUT)	7
3.2 OPERATION	8
3.2.1 MAIN INDEX.....	8
3.2.2 SEQ. TEST	9
3.2.3 SINGLE STEP MANUAL TEST PAGE	14
3.2.4 CONTINUES AUTO TEST PAGE	16
3.2.5 NULL TEST PAGE	17
3.2.6 ALUMINIUM FOIL WITHSTANDING VOLTAGE TEST PAGE	18
3.2.7 COMPARE FUNCTION SETTING PAGE.....	23
3.2.8 FILE STORAGE PAGE	24
3.2.9 SYSTEM CONFIGURATION PAGE	26
CHAPTER 4 TEST PERFORMANCE	38
4.1 (L.C./I.R. TEST)	38
4.1.1 PARAMETER	38
4.1.2 TEST SIGNAL	38
4.1.3 BASIC ACCURACY	39
4.1.4 DISPLAY RANGE.....	39
4.1.5 TEST TIME	39
4.1.6 (NULL)	39

4.2 (W.V. TEST)	39
4.2.1 TEST PARAMETER	39
4.2.2 TEST SIGNAL	39
4.2.3 DISPLAY RANGE.....	39
<u>CHAPTER 5 REMOTE CONTROL</u>	<u>41</u>
5.1 RS232C INTERFACE INTRODUCTION	41
5.1.1 RS232C CONNECTION.....	41
5.1.2 COMMUNICATION WITH A COMPUTER	43
5.2 GPIB.....	43
5.2.1 GPIB BUS.....	43
5.2.2 GPIB FUNCTION	45
5.2.3 GPIB ADDRESSING	46
<u>CHAPTER 6 COMMAND REFERENCE</u>	<u>47</u>
6.1 SHARING COMMAND INSTRUCTION	47
6.2 SCPI ORDER STRUCTURE.....	48
6.2.1 ORDER STRUCTURE INSTRUCTION	49
6.3 ORDER SYNTAX	50
6.4 SCPI ORDER INSTRUCTION	51
6.4.1 ABORT ORDER SYSTEM.....	51
6.4.2 CALCULATE ORDER SYSTEM.....	51
6.4.3 DISPLAY ORDER SYSTEM.....	53
6.4.4 LCTEST ORDER SYSTEM	53
6.4.5 WVTEST ORDER SYSTEM.....	55
6.4.6 TRIGGER ORDER SYSTEM.....	56
6.4.7 SYSTEM ORDER SYSTEM.....	57
6.5 ERROR INFORMATION.....	58
<u>CHAPTER 7 SORTING INTERFACE INSTRUCTION</u>	<u>59</u>
7.1 HANDLER INTERFACE	59
7.2 THE JUMPER SET ON HANDLER BOARD.....	60
7.3 HANDLER INTERFACE SIGNAL DIAGRAM.....	61

Chapter 1 Introduction

Thanks very much for choosing and using our product. If you have any questions after reviewing this manual, please contact your local representative or call directly to our application engineers for further consultation.

1.1 Introduction

Basic specification: (more in Chapter 4)

- Test parameter:

Leakage current test: L.C. (Leakage Current), I.R. (Isolated Resistance)

Withstanding voltage test: Tr, Vt

- Basic accuracy:

L.C.----- $\pm (0.3\%+0.05\mu\text{A})$

- Test range:

L.C.-----0.000 μA \sim 20.00 mA

- Test voltage/charging current:

Test voltage LEV = 1.0V \sim 100V, resolution 0.1V

= 101V \sim 800V, resolution 1V; $\pm (0.5\%+0.2\text{V})$ [TH2689]

= 101V \sim 500V, resolution 1V; $\pm (0.5\%+0.2\text{V})$ [TH2689A]

Charging current LEV \leq 100V: 0.5 mA \sim 500 mA, resolution 0.5 mA

$>$ 100V: 0.5 mA \sim I_{MAX}, resolution 0.5 mA; $\pm (3\%+0.05\text{mA})$

- Correction : Null

● IEEE-488 interface (optional): this interface provides convenience for instrument and computer or other instruments to make a automatical test system.

The command of RS-232C and IEEE-488 interface is written by **SCPI** format.

● HANDLER interface: the instrument is synchronized with the machinery processing instrument in automatical test system, and the result is output to the machinery processing instrument.

1.2 Condition

1.2.1 Power \swarrow

Voltage: 220V(1 \pm 10%)

Frequency: 50Hz/60Hz(1 \pm 5%)

Consumption: <120VA

1.2.2 Environmental temperature and humidity

Normal working temperature: 0 $^{\circ}$ C \sim 40 $^{\circ}$ C, humidity: < 90%RH

Reference working temperature: $20^{\circ}\text{C}\pm 8^{\circ}\text{C}$, humidity: $< 80\%RH$

Transportation temperature: $0^{\circ}\text{C}\sim 55^{\circ}\text{C}$, humidity: $\leq 93\%RH$

1.2.3 Warm-up

Warm up time: ≥ 20 min.

1.2.4 Caution

1. Please do not operate the instrument in the places where is vibrative, dusty, under direct sunlight, or where there is corrosive air.
2. Although the instrument has been specially designed for reducing the noise caused by ac power, a place with low noise is still recommended. If this cannot be arranged, please make sure to use power filter for the instrument.
3. Please store the instrument in the place where temperature is between 5°C and 40°C , humidity is less than $85\%RH$. If the instrument will not be put in use for a time, please have it properly packed with its original box or a similar box for storing.
4. TH2816B has the cooling fan on the rear panel and cooling holes on both sides. High temperature inside will decrease the measurement accuracy, so sufficient space must be kept around the TH2816B to avoid obstructing the air flow of the cooling fans.
5. Don't frequently turn on and off the instrument, doing so will lead to the loss of the calibrated data and the data saved by users.

5.1 Dimension and weight

Dimension (W*H*D): $350\text{mm}\times 120\text{mm}\times 400\text{mm}$

Weight: about 7kg

5.2 Safety

The instrument is the class I

5.2.1 Insulated resistance

Under the reference working condition, the insulated resistance between powerterminal and shell is no less than $50M\Omega$;

Under transportaion condition, the insulated resistance between powerterminal and shell is no less than $2M\Omega$;

5.2.2 Insulation intensity

Under the reference working condition, the rated voltage between powerterminal and shell is 1.5kV, 50Hz AC voltage is 1 Min., no arc phenomenon.

5.2.3 Leakage current

Leakage current is no larger than 3.5mA.

5.3 Electromagnetic compatibility

Power instaneous sensitivity is based on GB6833.4

Transmission sensitivity is based on GB6833.6

Radiated interference is based on GB6833.10

Chapter 2 Instruction of front panel

2.1 Instruction of front panel

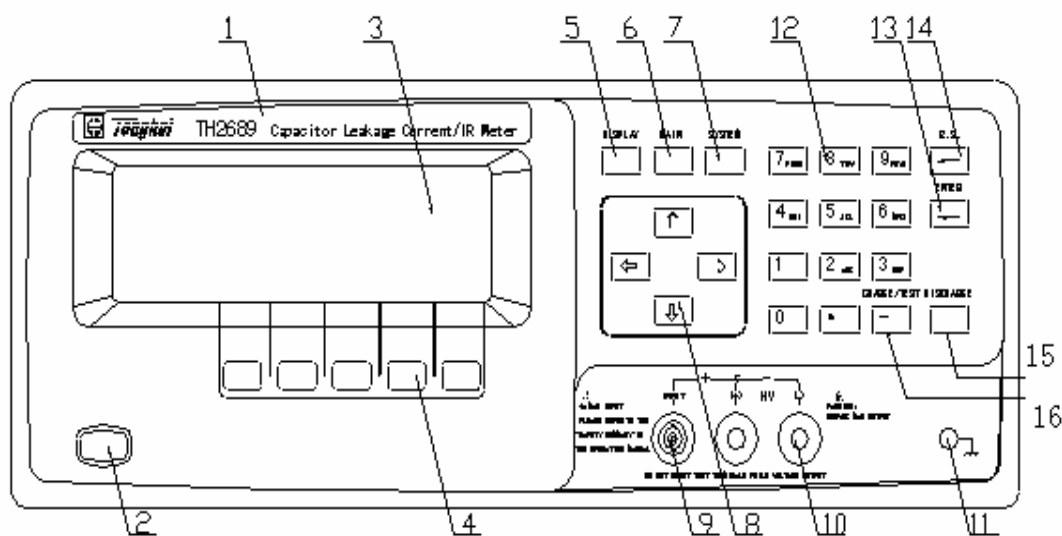

Figure 2-1

Figure 2-1 Instruction of front panel

No.	Name	Instruction
1	Brand and model	TH2689 or TH2689A Capacitor Leakage Current/IR Meter
2	POWER	Switch on and off 220V/110V power
3	LCD	240*64 dot-matrix LCD
4	SOFTKEYs	The five keys have different functions in different menus
No.	Name	Instruction
5	DISPLAY	For entering the previous page
6	MAIN	For entering the main function page
7	SYSTEM	For entering system setup page
8	CURSOR	For controlling the movement of cursor on the screen, the selected parameter is displayed

		with highlight.
9	UNKNOW	INPUT: current sampling terminal
10	Voltage output terminal	HV (-): negative voltage output terminal; ⚡ HV (+): voltage positive terminal;
11	Ground	Connect with shielding layer of the component to be tested , in order to separate the electromagnetic interface to improve the accuracy and stability.
12	number/letter keyboard	For inputting number or character if desired (file name) .
13	BACKSPACE	For deleting numbers or letters if desired.
14	ENTER	Confirm the inputed numbers .etc
15	DISCHARGE	The instrument enters discharging status.
16	CHARGE/TEST	Trigger test, when setting manual trigger, press the key to trigger a test.

2.2 Instruction of rear panel

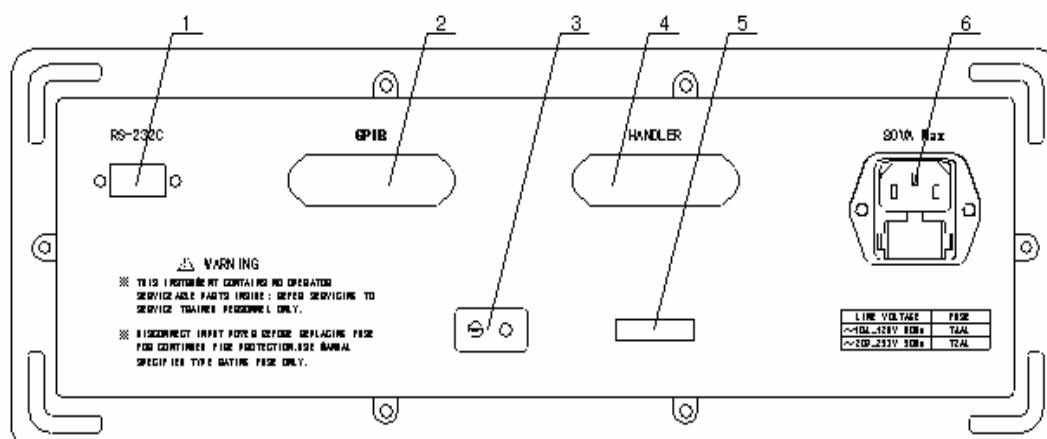

Figure 2-2

Figure 2-2 Instruction of rear panel

No.	Name	Instruction
1	RS232C	Provide the universal serial communication interface for instrument and external device. All parameter setup and command are set and obtained by computer to realize the remote control.
2	IEEE488 (optioanl)	Provide universal parallel communication interface for instrument and external device, the function is the same as 1
3	Ground	
4	HANDLER	The instrument outputs compare result viathis interface, and obtains "setup"signal via sorting interface.
5	Label plate	Record the date, model, manufacturer .etc
6	3-cable power socket	Connect the 220V/50Hz or 110V/60Hz AC power.

Chapter 3 Operation

3.1 Connection of (DUT)

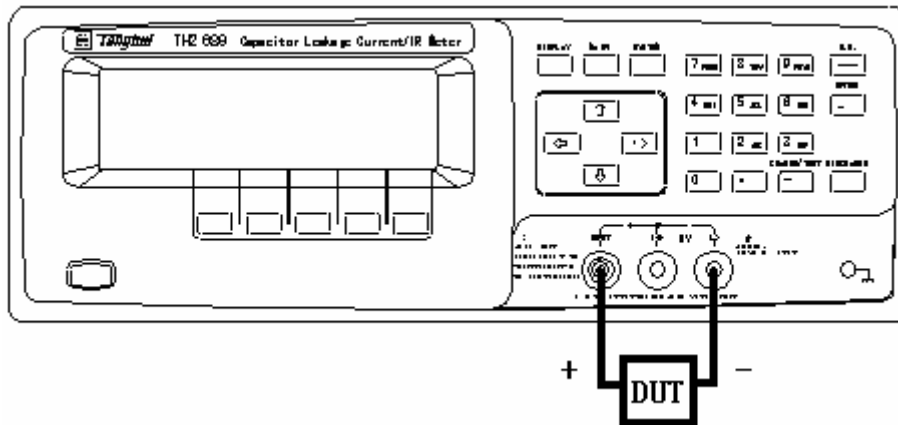

Figure 3-1



Note:

INPUT terminal is connected with positive terminal,

HV (-) outputs negative voltage, and connects the negative terminal of DUT.

3.2 Operation

3.2.1 MAIN INDEX

Press  to enter <MAIN INDEX> page, use direction key to move cursor , press  to enter the corresponded subfunction page, press  to return to the previous test page.

Shown as figure 3-2:

FILE : file storage page;

Calibration : calibration page, not for user.

<MAIN INDEX>	
(1) SEQ. TEST	(6) COMPARE
(2) STEP TEST	(7) FILE
(3) CONT TEST	(8) Calibration
(4) NULL	
(5) W. V. TEST	
	ESC OK

Figure 3-2

Page	Explanation	Instruction
SEQ. TEST	In-turn auto test page	The process of charge, test, discharge is finished automatically after triggering
STEP TEST	One-step manual test page	Trigger to enter charging status, and enters test status after charging, manual discharge is required
CONT TEST	Sequence auto test page	Charge after triggering, enter test status, once the external capacitor without electricity is connected to the test terminal, then discharge manually in auto trigger charge, test.
NULL	Null test page	
W.V. TEST	Aluminium foil withstanding voltage	

	test page	
COMPARE	Compare function setting page	
FILE	File storage page	
Calibration	Calibration page	Not for user

3.2.2 SEQ. TEST

On this page, just press , the instrument can finish charge, test, discharge automatically.

3.2.2.1 <SEQ.TEST>

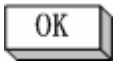
On <MAIN INDEX> page, use direction key to move cursor to“ (1) SEQ. TEST”, then press  to enter<SEQ.TEST> page, there are two pages on <SEQ.TEST>, shown as figure 3-3:

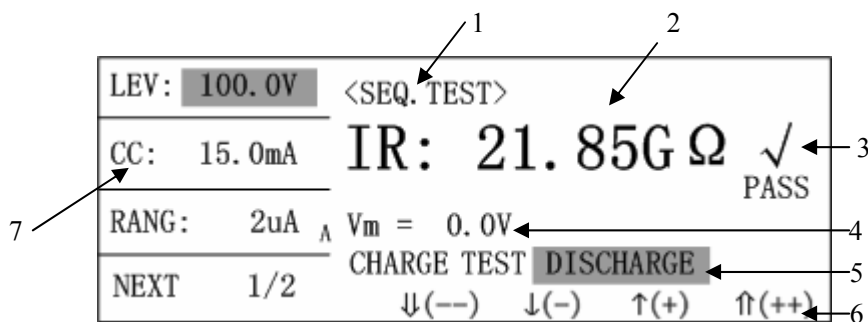

Figure 3-3 (a) SEQ.TEST page 1

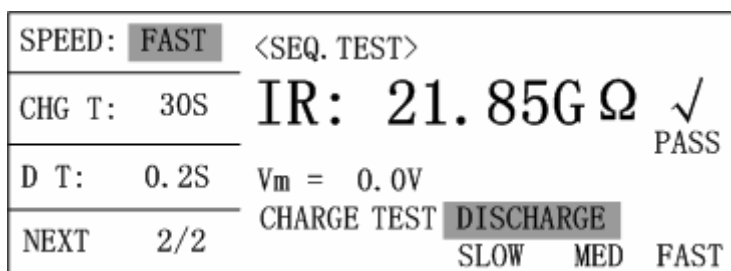



Figure 3-3 (b) SEQ.TEST page 2

※Note:

(1) In (CHARGE) status, parameter can't be set, and in (TEST) status, the parameter of (RANG) and (SPEED) can be set.

(2) In the status of (CHARGE) and (TEST), press  to return to the discharge status.

(3) when TRIG mode is set as BUS、EXT, the trigger signal is controlled by external interface, and it is invalid to press .

3.2.2.2 Instruction of displayed file

Shown as figure 3-3 (a):

1	Name
2	Test function parameter (LC/IR) and test result
3	Compare result: (√PASS), (×HIGH), (×LOW); if compare function is off, there is no display
4	Voltage monitor
5	Current procedure
6	Softkey zone
7	Test parameter setup

3.2.2.3 Instruction of setting test parameter

(1) Test voltage (LEV), range 1V~800V (TH2689) / 1V~500V (TH2689A)

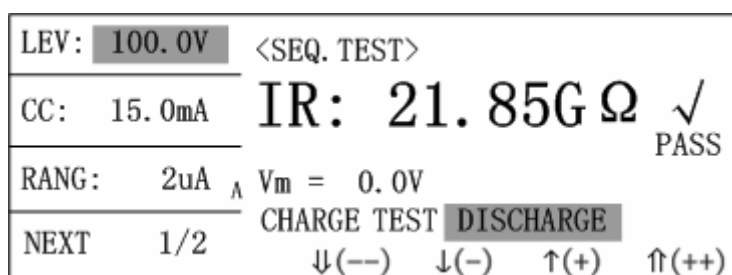

Figure 3-4 Setup of test voltage

Move cursor to “LEV: 100.0V”, operate according to the table below:

	Coarse turning, from small to large : 6.3→10.0→16.0→25.0→35.0→50.0→63.0→100.0→160.0→200.0→250.0→350.0→400.0→450.0→500.0 (→550.0→600.0→630.0→800.0)
	Coarse turning, from large to small : 6.3←10.0←16.0←25.0←35.0←50.0←63.0←100.0←160.0←200.0←250.0←350.0←400.0←450.0←500.0 (←550.0←600.0←630.0←800.0)
	Fine turning, when LEV ≥ 100.0V, stepper is +1V; When LEV < 100.0V, stepper is +0.1V
	Fine turning, when LEV ≥ 100.0V, stepper is -1V; When LEV < 100.0V, stepper is -0.1V
Numeric key	Input test voltage value directly (default unit is V), press ENTER to confirm

(2) Charging current (CC), range 0.5mA~500mA

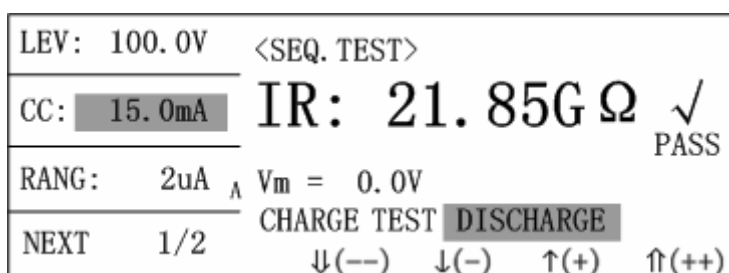

Figure 3-5 Setup of charging current

※Note:

When LEV ≤ 100V, ***I_{max}* = 500mA**;

When LEV > 100V, the Max. charge current is limited by power, and use P=UI to obtain

$$I_{max} = P / LEV \quad \text{---} \text{---} \text{---} \quad (P = 50W)$$

Move cursor to “CC: 15.0mA”, and operate according to the table below:

	Coarse turning. When CC ≥ 100.0mA, stepper is +50.0mA; When CC < 100.0mA, stepper is +5.0mA;
	Coarse turning. When CC > 100.0mA, stepper is -50.0mA; When CC ≤ 100.0mA, stepper is -5.0mA;

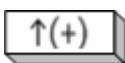
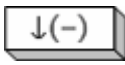
	Fine turning. Stepper is +0.5 mA;
	Fine turning. Stepper is -0.5 mA;
Numeric key	Input charging current value directly (default unit is mA), press ENTER to confirm

(3) (RANG), small character A means AUTO, H means HOLD

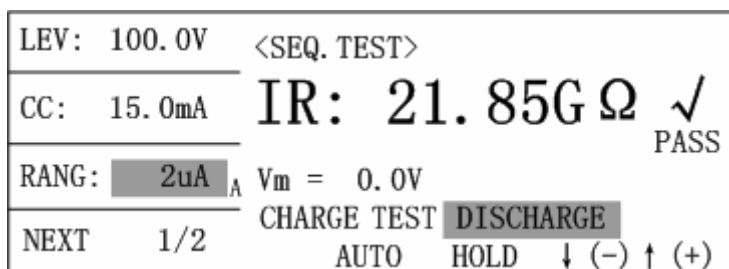

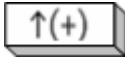
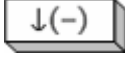

Figure 3-6 setup of range gear

Move cursor to “RANG: 2uA A”, operate according to the table below:

	Auto range gear, ‘A’ is displayed in the current range
	Lock range gear, ‘H’ is displayed in the current range
	Select range gear, 2uA → 20uA → 200uA → 2mA → 20mA
	Select range gear, 20mA → 2mA → 200uA → 20uA → 2uA

(4) (SPEED)

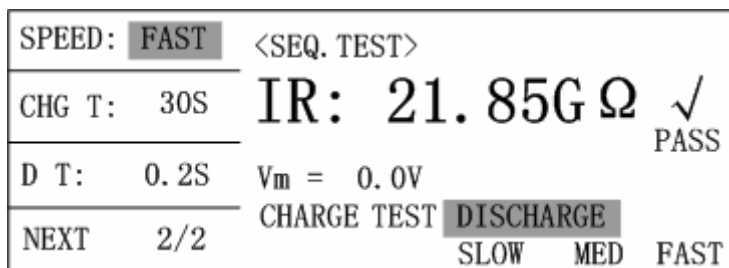





Figure 3-7 Setup of test speed

Move cursor to “SPEED: FAST”, operate according to the table below:

	Fast
	Middle
	Slow

Note: the speed is slower and the test result is more stable.

(5) (CHG T), range 0Sec~999Sec,

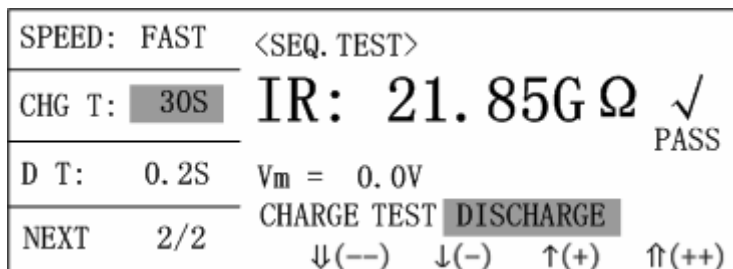
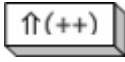
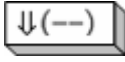
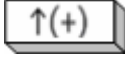
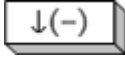

Figure 3-8 setup of charging time

Move cursor to “CHG T: 30S”, operate according to the table below:

	Coarse turning. When CHG T ≥ 100Sec, stepper is +100Sec; When CHG T < 100Sec, stepper is +10Sec;
	Coarse turning when CHG T > 100Sec, stepper is -100Sec; When CHG T ≤ 100Sec, stepper is -10Sec;
	Fine turning. Stepper is +1 Sec;
	Fine turning. Stepper is -1Sec;
Numeric key	Input charging time directly (default unit is Sec), press ENTER to confirm

(6) delay test time (D T), range 0.2Sec~999.0Sec, the time is the one from charge finishing to test starting, which is stable.

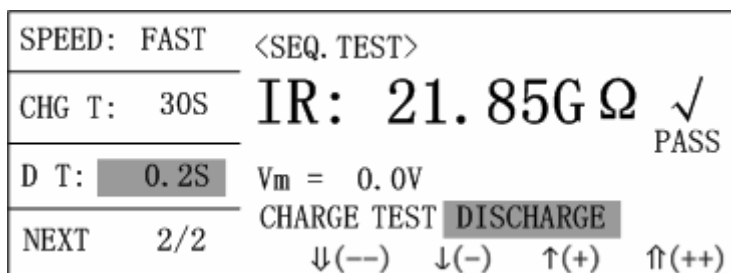

Figure 3-9 Setup of delay test time

Move cursor to "D T: 0.2S", operate according to the table below:

	Coarse turning. When D T ≥ 100Sec, stepper is +10Sec; When D T < 100Sec, stepper is +1Sec;
	Coarse turning. When D T > 100Sec, stepper is -10Sec; When D T ≤ 100Sec, stepper is -1Sec;
	Fine turning. Stepper is +0.1 Sec;
	Fine turning. Stepper is -0.1Sec;
Numeric key	Input charging time directly (default unit is Sec), press ENTER to confirm

(7) Turn page (NEXT 1/2 and NEXT 2/2)

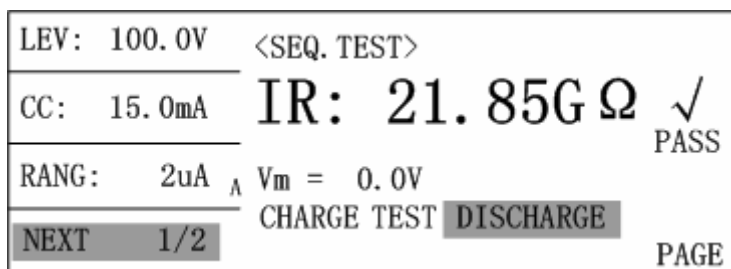

Figure 3-10

As figure 3-10 press or to enter the second page on < SEQ.TEST> (as figure 3-3) .

3.2.3 Single step manual test page

Oh the page, press , the instrument enters charging

step; and press **CHARGE/TEST** to tes; finally press **DISCHARGE** to return to discharge status.

3.2.3.1 <STEP TEST>

On <MAIN INDEX> page, use direction key to move cursor to“ (2) STEP TEST”, press **OK** to enter <STEP TEST>, there are 2 pages on <STEP TEST>, shown as figure 3-11:

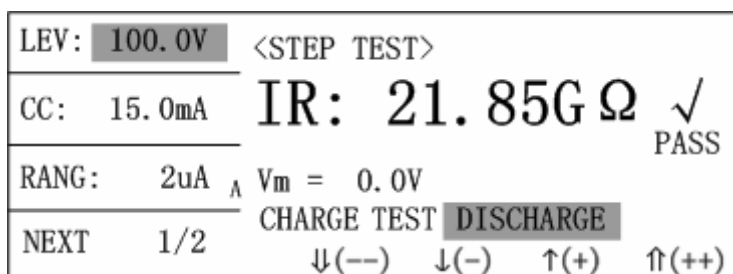

Figure 3-11 (a) STEP TEST page 1

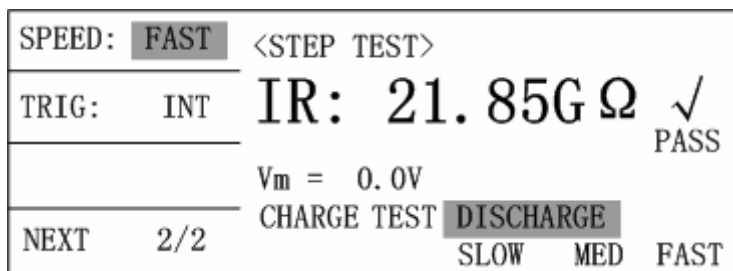

Figure 3-11 (b) STEP TEST page 2

※Note:

(1) In CHARGE status, parameter can't be set, in TEST status, only RANG and SPEED can be set.

(2) In the status of CHARGE and TEST, press **DISCHARGE** to return to discharge status.

(3) TRIG mode is set as BUS、EXT, trigger signal is controlled by external interface, it is invalid to press **CHARGE/TEST**.

3.2.3.2 Instruction of setting parameter

- (1) LEV、CC、RANG、SPEED see §3.2.2.3
- (2) Trigger mode (TRIG)

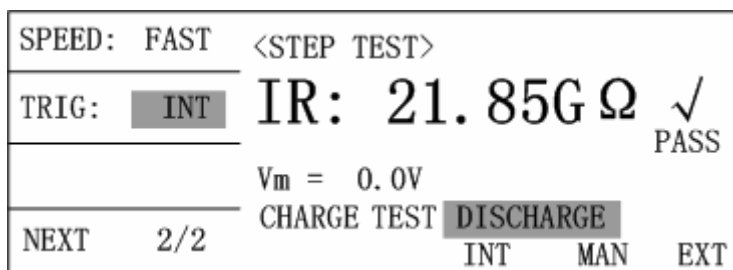





Figure 3-12 setup of trigger mode

Move cursor to “TRIG: INT”, operate according to the table below:

	Internal auto trigger
	Manual trigger
	External trigger

※Note: BUS (bus trigger) is set by bus command

3.2.4 Continues auto test page

On the function page, press , the instrument performs a procedure of charge and test; if a capacitor without electricity is connected to the test terminal, then trigger a procedure of charge and test automatically.

Finally press  to return to discharge status. The function is suitable for continues manual test status without discharge.

3.2.4.1 <CONT TEST>

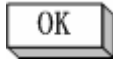
On <MAIN INDEX>page, use direction key to move cursor to “ (3) CONT TEST”, and press  to enter <CONT TEST>page, there are 2 pages on <CONT TEST>, shown as the figure 3-13:



图 3-13 (a) CONT TEST 第一页选项



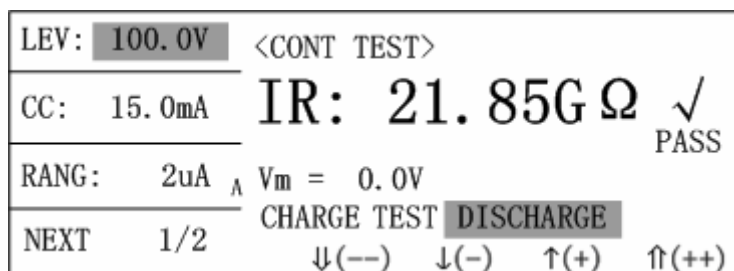

图 3-13 (b) CONT TEST page 2

※Note:

(1) In CHARGE status, parameter can't be set, in TEST status, only RANG and SPEED can be set.

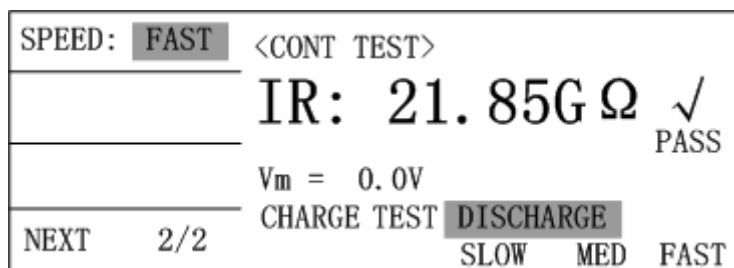

(2) In the status of CHARGE and TEST, press  to return to discharge status.

3.2.4.2 Set parameter instruction

(1) LEV、CC、RANG、SPEED, see §3.2.2.3

3.2.5 Null test page

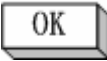
3.2.5.1 <NULL> page

On <MAIN INDEX> page, use direction key to move cursor to “ (4) NULL”, and press  to enter <NULL> page (shown as 3-14). on this page, press  to start null test.

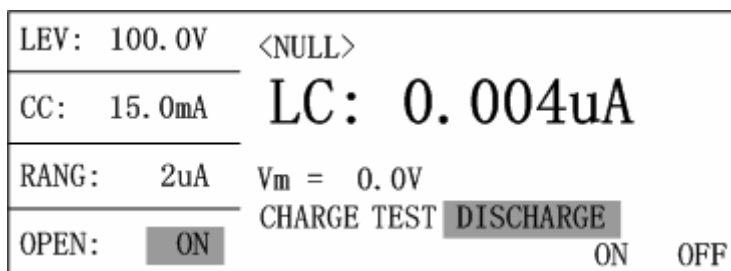

Figure 3-14 Null test page

3.2.5.2 Parameter setup

- (1) LEV, CC is only used to display the current test parameter, no modification
- (2) RANG displays the range in the process of null.
- (3) Null function setup setting (OPEN)

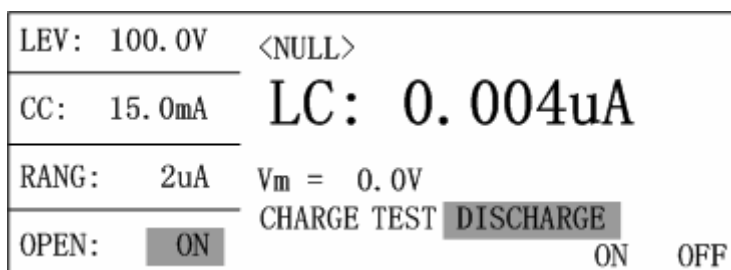



Figure 3-15

Move cursor to “OPEN: ON”, operate according to the table below:

	Turn on null function
	Turn off null function

3.2.6 Aluminium foil withstanding voltage test page

⚡ Connecting on and off the DUT incorrectly will damage human body seriously due to the high voltage on test terminal in the process of “W.V. TEST”!!!

The correct connection method is to make the instrument in the discharging status.

3.2.6.1 <W.V. TEST>

On <MAIN INDEX>, use direction key to move cursor to“ (5) W.V.

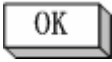
TEST”, and press  to enter <W.V. TEST> page (shown as figure 3-16) .

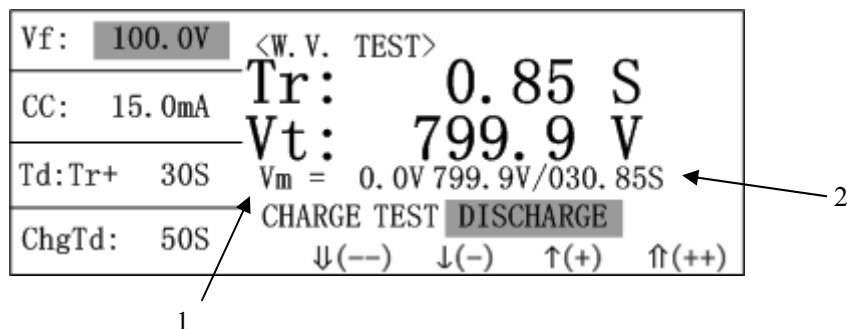

Figure 3-16 W.V. TEST

3.2.6.2 Set parameter and instruction of displayed parameter

Vf: rated leather withstanding voltage.

CC: W.V charging current.

Tend: Tr+ identified withstanding voltage time.

ChgTD: set charge high limit time.

Tr: display the rising time when test voltage reaches 90%Vf.

Vt: display the voltage when test time reaches Td (Tend);

1: monitor the voltage value at output terminal;

2: display the final tested voltage and time when test ends;

3: if the test is cancelled in the process, only press  to enter discharge status at anytime.

3.2.6.3 Parameter setting

(1)Rated feather withstanding voltage(Vf): range 1V~800V(TH2689)/ 1V~

500V (TH2689A)

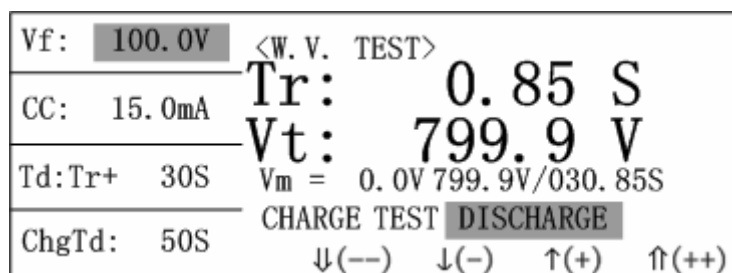

Figure 3-17

Move cursor to “Vf: 100.0V”, operate according to the table below:

↑(++)	Coarse turning, from small to large: 6.3→10.0→16.0→25.0→35.0→50.0→63.0→100.0→160.0→200.0→250.0→350.0→ 400.0→450.0→500.0 (→550.0→600.0→630.0→800.0)
↓(--)	Coarse turning, from large to small: 6.3←10.0←16.0←25.0←35.0←50.0←63.0←100.0←160.0←200.0←250.0←350.0← 400.0←450.0←500.0 (←550.0←600.0←630.0←800.0)
↑(+)	Fine turning, stepped is +0.1V
↓(-)	Fine turning, stepper is -0.1V
Numeric key	Input rated feather withstanding voltage value directly, and press ENTER to confirm

(2) W.V charge current (CC), range 0.5mA~IMAX

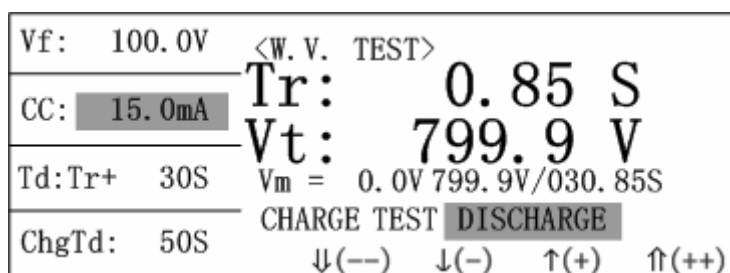

Figure 3-18 charge current setting

※Note:

Max. charge current in limited by power, according to $P=UI$

$$I_{max} = P / V_{MAX} \quad \text{---} \quad (P = 65W, V_{MAX} \text{ see } Vf)$$

Move cursor to “CC: 15.0mA”, operate according to the table below:

	Coarse turning. Stepper is +5.0mA;
	Coarse turning. Stepper is -5.0mA;
	Fine turning. Stepper is +0.5 mA;
	Fine turning. Stepper is -0.5 mA;
Numeric key	Input W.V charge current value directly, press ENTER to confirm

(3) W.V test time (Td), range 0Sec~600Sec

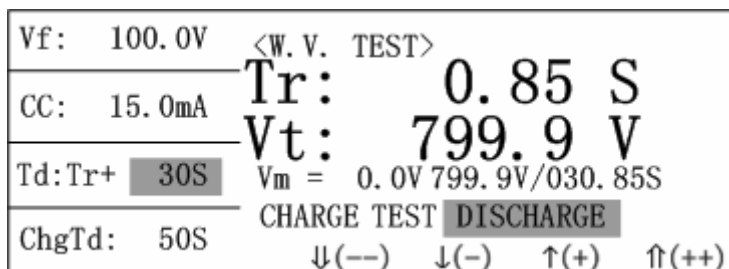

Figure 3-19

Move cursor to “Td: Tr+ 30S”, operate according to the table below:

	Coarse turning. When set value ≥ 100 Sec, stepper is +100Sec; Otherwise, stepper is +10S;
	Coarse turning. When set value ≥ 100 Sec, stepper is -100Sec; Otherwise, stepper is -10Sec;
	Fine turning. Stepper is +1Sec;
	Fine turning. Stepper is -1Sec;
Numeric key	Input W.V charge current value directly, press ENTER to confirm

(4) W.V charge time high limit (ChgTd), range 5Sec~600Sec

Vf: 100.0V	<W.V. TEST>
CC: 15.0mA	Tr: 0.85 S
Td:Tr+ 30S	Vt: 799.9 V
ChgTd: 50S	Vm = 0.0V 799.9V/030.85S
	CHARGE TEST DISCHARGE
	↓(--), ↓(-), ↑(+), ↑(++)

Figure 3-20 charge time high limit setup

Move cursor to “ChgTd: 50S”, operate according to the table below:

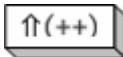
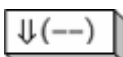
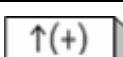
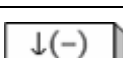
	Coarse turning. Stepper is +30Sec;
	Coarse turning. Stepper is -30Sec;
	Fine turning. Stepper is +5Sec;
	Fine turning. Stepper is -5Sec;
Numeric key	Input W.V charge current value directly, press ENTER to confirm

3.2.6.4 <W.V. TEST> notes

The correct method of cancelling test: when the instrument is in the status of discharge, the DUT can be connected on and off.

Press  , the instrument is in the status of discharge, now the DUT can be connected off; when the DUT is connected, the instrument should be in the status of discharge .

3.2.7 Compare function setting page

3.2.7.1 <COMPARE>

On <MAIN INDEX> page, use direction key to move cursor to“ (6)

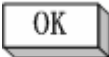
COMPARE”, and press  to enter <COMPARE> (shown as 3-21).

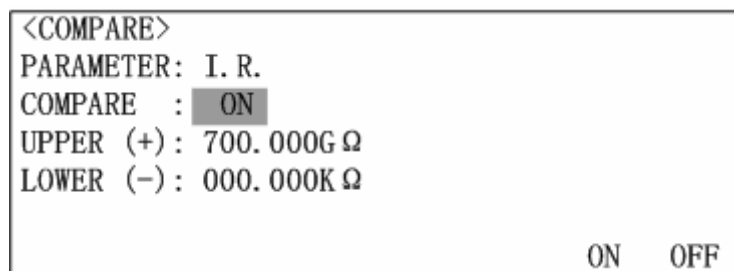

Figure 3-21 COMPARE

3.2.7.2 Parameter setting

- (1) PARAMETER: display the current compare parameter mode, it can't be modified here, if modify see §3.2.9.1 .
- (2) (COMPARE)

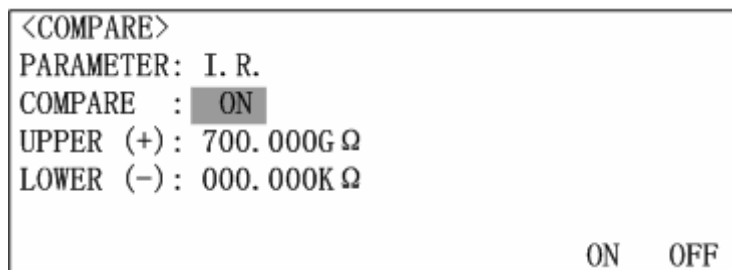



Figure 3-22

Move cursor to“COMPARE: ON”, operate according to the table below:

	Turn on comparator function
	Turn off comparator function

- (3) (UPPER)

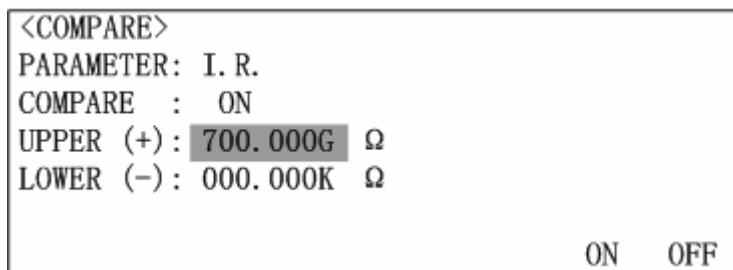



Figure 3-23

	Turn on the comparator upper limit function
	Turn off the comparator upper limit function
Numeric key	Input comparator upper limit function value directly

(4) (LOWER)

Refer to comparator upper limit setting.

3.2.8 File storage page

3.2.8.1 <FILE>

On <MAIN INDEX>, use direction key to move cursor to“(7) FILE”,

and press  to enter <FILE> (shown as figure 3-24) .

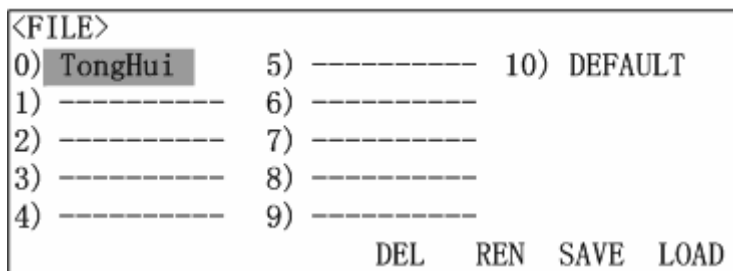





Figure 3-24 FILE

	Load file
	Save file

	Rename file
	Delete file

3.2.8.2 File storage operation

(1) 0~9 files can be saved, No. 10 file is the default file which is used to recover the default status.

(2) “-----”means there is no corresponding file storage

(3) Stored file flowchart

Press , page turns to file input, shown as figure 3-25:

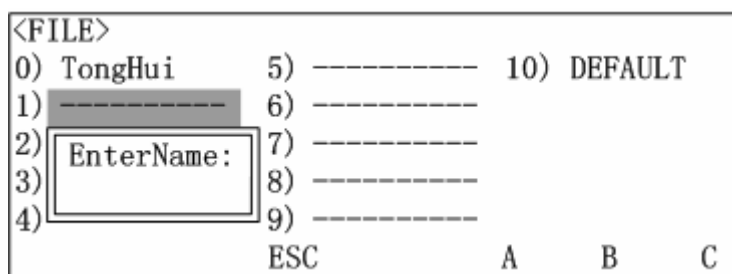



Figure 3-25 Input file name

After inputting file name, press  to confirm, the page displays saving processing table, shown as figure 3-26:

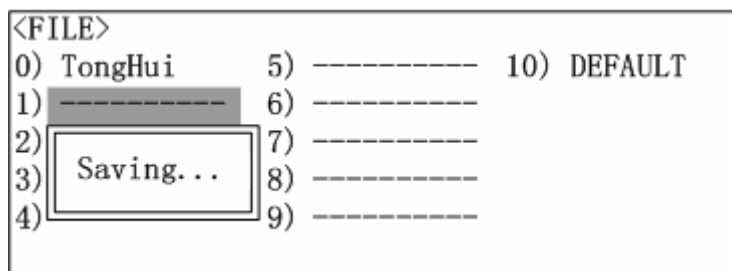

Figure 3-26

After saving, page displays as figure 3-27 (if file name is“A”):

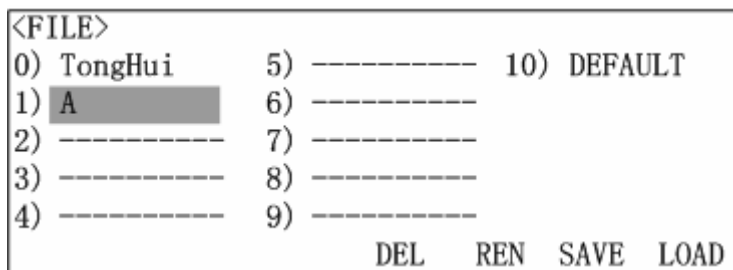

Figure 3-27

3.2.9 System configuration page

Press **SYSTEM**, enter<SYSTEM CONFIG>, there are 3 pages , shown as figure 3-28:

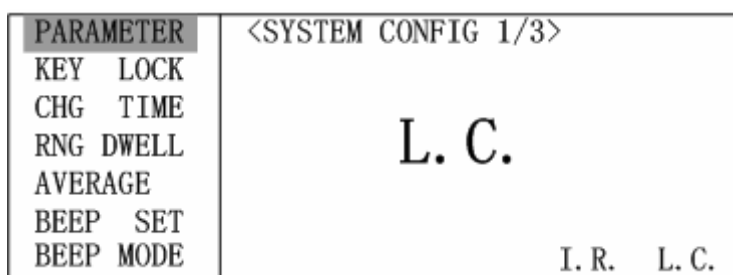

Figure 3-28 (a) SYSTEM CONFIG page 1

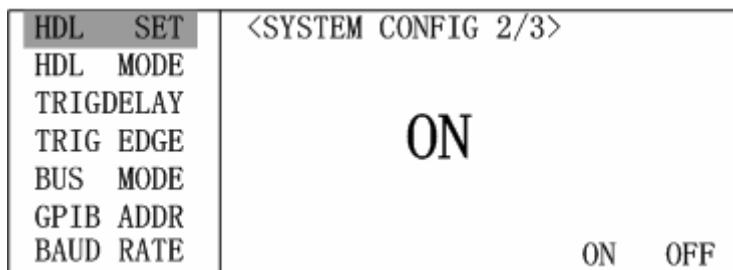

Figure 3-28 (b) SYSTEM CONFIG page 2

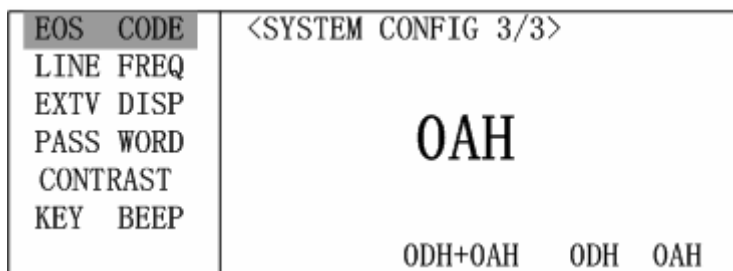

Figure 3-28 (c) SYSTEM CONFIG page 3

3.2.9.1 System parameter setting

(1) (PARAMETER), default is L.C.

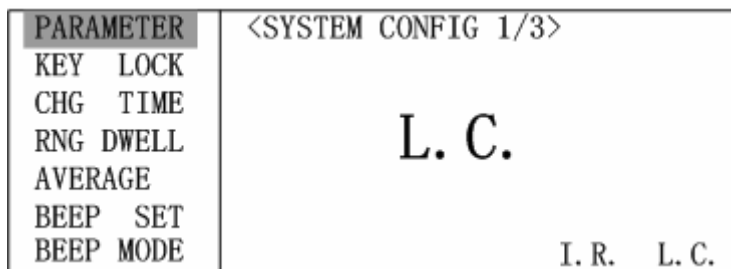



Figure 3-29

Move cursor to "PARAMETER":

	Parameter is set as (I.R.)
	Parameter is set as (L.C.)

(2) (KEY LOCK), default is OFF

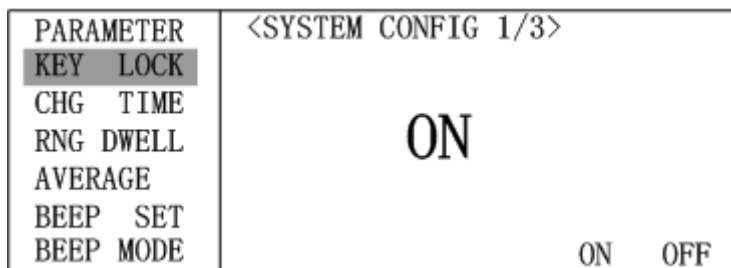



Figure 3-30

Move cursor to "KEY LOCK":

	Turn on key lock, when the page is switched to test function page , the former softkey zone displays“KeyLock” which means key is locked. If unlock the function, it is necessary to input(PASS WORD), refer to the instruction of PASS WORD on page 3.
	Turn off key lock

(3) (CHG TIME), default is $V_m=V_s$

PARAMETER	<SYSTEM CONFIG 1/3>
KEY LOCK	
CHG TIME	$V_m = V_s$
RNG DWELL	
AVERAGE	
BEEP SET	
BEEP MODE	$V_m=0V$ $V_m=V_s$

Figure 3-31

Move cursor to “CHG TIME”:

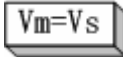
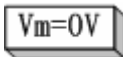
	Calculate the charge time from $V_m=V_s$
	Calculate the charge time from $V_m=0V$

※According to JIS(Japanese Industrial Standards,), after the DUT is charged to the rated working voltage, calculate the charge time, so please select $V_m=V_s$ in order to meet the rules of JIS.

(4) Switch range interval time (RNG DWELL), range 0.0Sec~9.9Sec, default is 0.0Sec

PARAMETER	<SYSTEM CONFIG 1/3>
KEY LOCK	
CHG TIME	
RNG DWELL	0.0S
AVERAGE	
BEEP SET	
BEEP MODE	↓ (-) ↑ (+)

Figure 3-32

Move cursor to “RNG DWELL”:

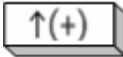
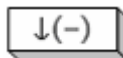
	+0.1Sec
	-0.1Sec
Numeric key	Input switch range interval time directly, default unit is Sec

(5) Test average time (AVERAGE), range 1~8, default is 1.

PARAMETER	<SYSTEM CONFIG 1/3>
KEY LOCK	
CHG TIME	
RNG DWELL	1
AVERAGE	
BEEP SET	
BEEP MODE	↓ (-) ↑ (+)

Figure 3-33

Move cursor to “AVERAGE”:

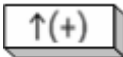
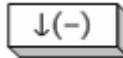

	+1
	-1
Numeric key	Input average time directly

(6) (BEEP SET), default is ON

PARAMETER	<SYSTEM CONFIG 1/3>
KEY LOCK	
CHG TIME	
RNG DWELL	ON
AVERAGE	
BEEP SET	
BEEP MODE	ON OFF

Figure 3-34

Move cursor to “BEEP SET”:



	Sound
	Silence

(7) (BEEP MODE), default is FAIL

PARAMETER	<SYSTEM CONFIG 1/3>
KEY LOCK	
CHG TIME	
RNG DWELL	FAIL
AVERAGE	
BEEP SET	
BEEP MODE	PASS FAIL

Figure 3-35

Move cursor to “BEEP MODE”:



	Alarm when the test result is pass in COMPARE
	Alarm when the test result is fail in COMPARE
	Turn to the second page of SYSTEM CONFIG

(8) HANDLE (HDL SET), default is ON

HDL SET	<SYSTEM CONFIG 2/3>
HDL MODE	
TRIGDELAY	
TRIG EDGE	ON
BUS MODE	
GPIB ADDR	
BAUD RATE	ON OFF

Figure 3-36 HANDLER

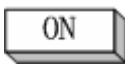
Move cursor to “HDL SET”:



	HANDLER interface is allowed
	HANDLER interface is forbidden
	Turn back to the first page of SYSTEM CONFIG

(9) HANDLER (HDL MODE), default is CLEAR

HDL SET	<SYSTEM CONFIG 2/3>
HDL MODE	
TRIGDELAY	
TRIG EDGE	CLEAR
BUS MODE	
GPIB ADDR	
BAUD RATE	HOLD CLEAR

Figure 3-37 HANDLER

Move cursor to “HDL MODE”:

	CLEAR mode, when using HANDLER interface, before testing, clear out the output signal of last test (PASS or FAIL)
	HOLD mode, when using HANDLER, the output signal (PASS or FAIL) will be changed until the next result being changed

(10) (TRIGDELAY), range 0~9999mSec, default is 0mSec

HDL SET	<SYSTEM CONFIG 2/3> 0000mS
HDL MODE	
TRIGDELAY	
TRIG EDGE	
BUS MODE	
GPIB ADDR	
BAUD RATE	

Figure 3-38

Move cursor to “TRIGDELAY”:



Numeric key	Input delay time directly, default value is mSec
-------------	--

(11) (TRIG EDGE), default is FALLING

HDL SET	<SYSTEM CONFIG 2/3> FALLING
HDL MODE	
TRIGDELAY	
TRIG EDGE	
BUS MODE	
GPIB ADDR	
BAUD RATE	

Figure 3-39

Move cursor to “TRIG EDGE”:

	(FALLING)
	(RISING)

(12) (BUS MODE), default is RS232

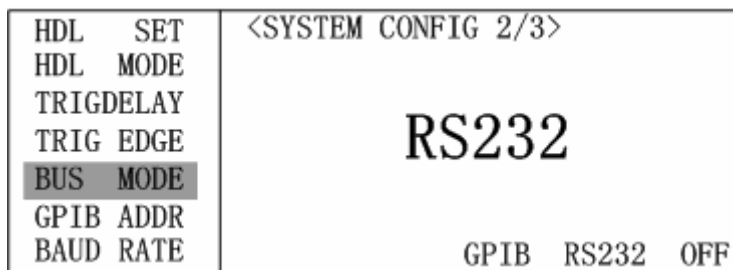





Figure 3-40 Bus mode setting

Move cursor to "BUS MODE":

	Use GPIB interface
	Use RS232 interface
	No bus control

(13) (GPIB ADDR), range 00~30, default is 08

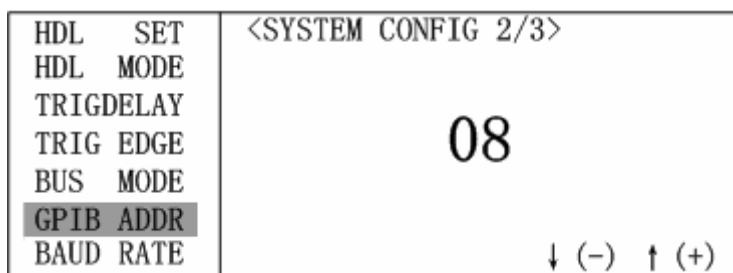
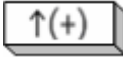
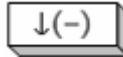

Figure 3-41

Move cursor to "GPIB ADDR":

	+1
	-1
Numeric key	Input GPIB address directly

(14) (BAUD RATE), 6 selections, default is 19200



HDL SET	<SYSTEM CONFIG 2/3> 19200	
HDL MODE		
TRIGDELAY		
TRIG EDGE		
BUS MODE		
GPIB ADDR		
BAUD RATE		600 1200 4800 9600 NEXT

Figure 3-42 (a)

HDL SET	<SYSTEM CONFIG 2/3> 19200	
HDL MODE		
TRIGDELAY		
TRIG EDGE		
BUS MODE		
GPIB ADDR		
BAUD RATE		19200 28800 NEXT

Figure 3-42 (b)

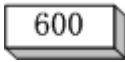
Move cursor to "BAUD RATE":





	Switch as figure 3-42
 	Select 600, 1200, 4800, 9600, 19200, 28800 baud rate
	Turn to the third page of SYSTEM CONFIG

(15) (EOS CODE), default is ASCII code 0AH

EOS CODE	<SYSTEM CONFIG 3/3> 0AH
LINE FREQ	
EXTV DISP	
PASS WORD	
CONTRAST	
KEY BEEP	

Figure 3-43

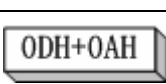
Move cursor to "EOS CODE":

	The selection of Eos data is ended with 0AH
	The selection of Eos data is ended with 0DH
	The selection of Eos data is ended with 0DH0AH
	Back to the second page of SYSTEM CONFIG

(16) (LINE FREQ), default is 50Hz

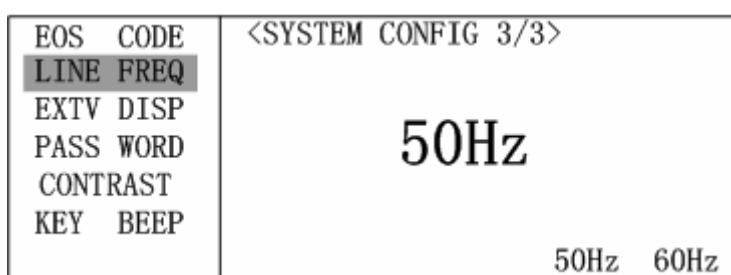



Figure 3-44

Move cursor to "LINE FREQ":

	Power frequency is 50Hz
	Power frequency is 60Hz

(17) EXT TV DISP, default is OFF

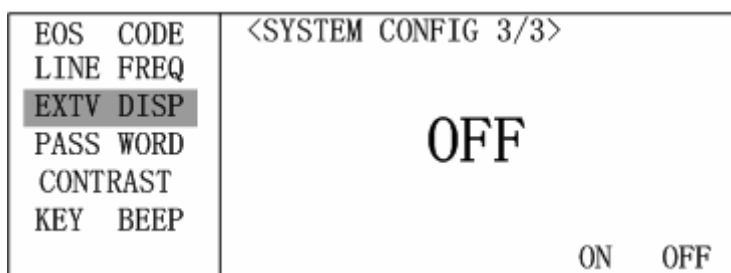
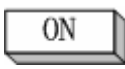



Figure 3-45 EXT TV DISP

Move cursor to "EXT TV DISP":

	When waiting for the external trigger signal, the tested voltage is displayed immediately
	When waiting for the external trigger signal, the tested voltage is not displayed

(18) (PASS WORD), the default password is “2689”

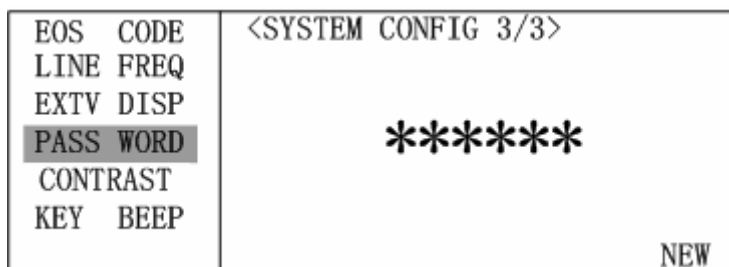

Figure 3-46

Move cursor to “PASS WORD”, if you modify the password, press



, then you should input your old password, shown as figure 3-47:

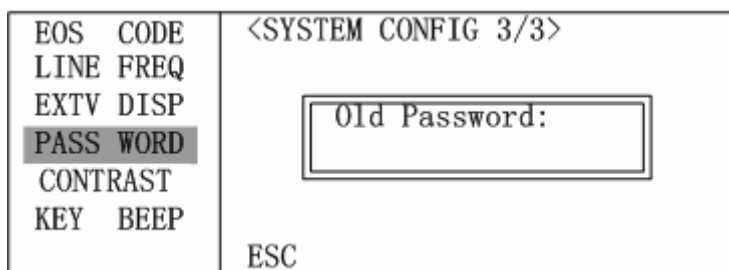



Figure 3-47

Press  to cancel the modification, use numeric key to input

password, the press  to confirm, if you input correctly, you can input the new password shown as figure 3-48:

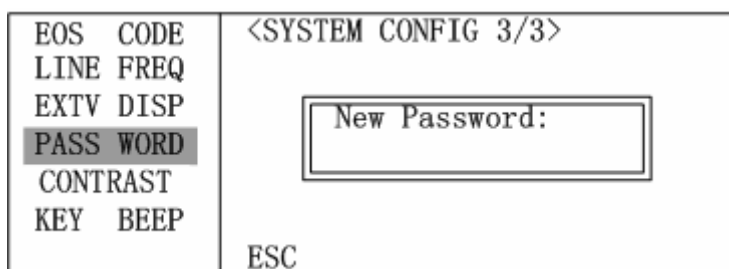



Figure 3-48

Use numeric key to input new password, press  to confirm and reinput the new password can be saved.

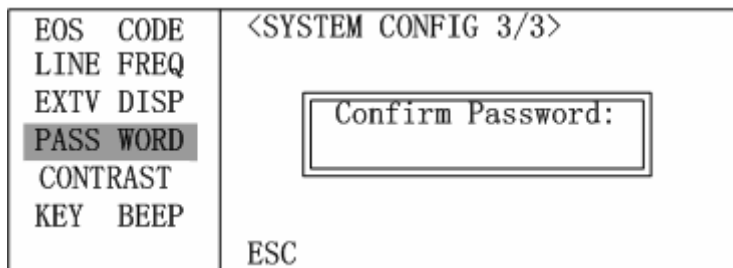

Figure 3-49

(19) (CONTRAST), range 0~31, the default is 15

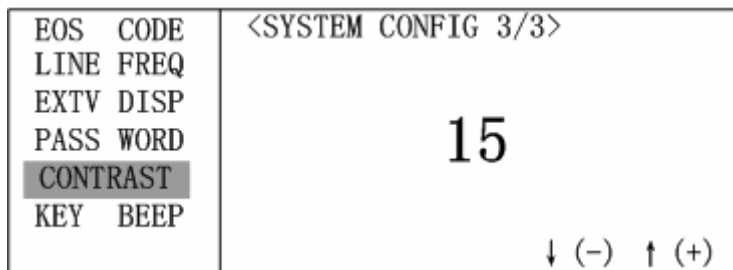
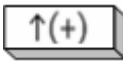
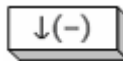

Figure 3-50

Move cursor to "CONTRAST":

	+1
	-1

(20) (KEY BEEP), the default is ON

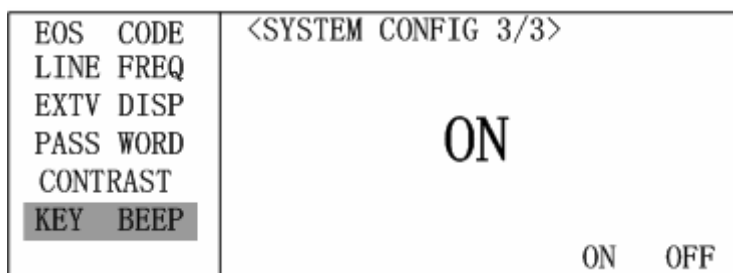
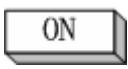



Figure 3-51

Move cursor to "KEY BEEP":

	Sound
	No sound

Chapter 4 Test performance

4.1 (L.C./I.R. TEST)

4.1.1 Parameter

Leakage current test: L.C. (Leakage Current), I.R. (Isolated Resistance)

4.1.2 Test signal

Test voltage LEV = 1.0V ~ 100V, resolution is 0.1V
 = 101V ~ V_{MAX}, resolution is 1V; ± (0.5%+0.2V)
 Charge current LEV ≤ 100V: 0.5 mA ~ 500 mA, resolution is 0.5 mA
 > 100V: 0.5 mA ~ I_{MAX}, resolution is 0.5 mA;
 ± (3%+0.05mA)

※ Note: V_{MAX} = 800V; (TH2689)
 = 500V; (TH2689A)

I_{MAX} = P/LEV; P = 50VA

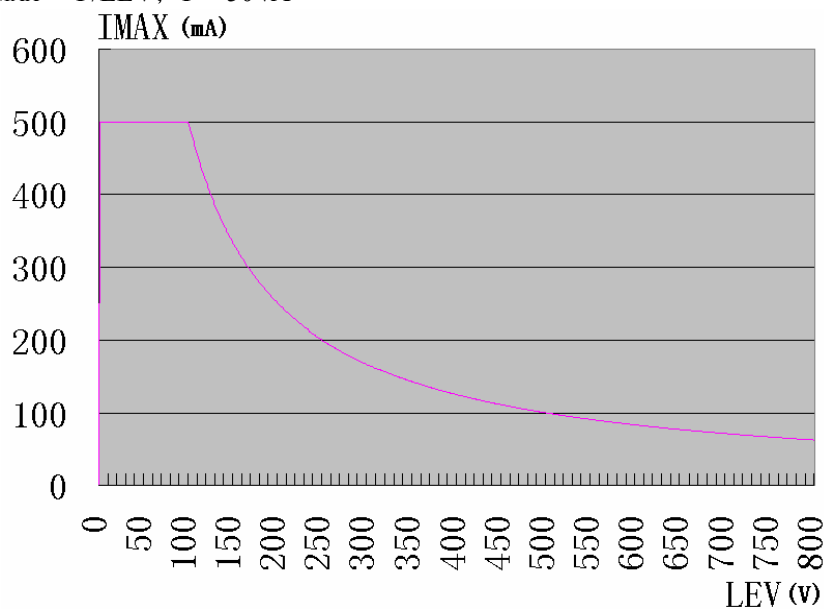

Figure 4-1 I_{MAX} and LEV curve

4.1.3 Basic accuracy

L.C.----- $\pm (0.3\%+0.05\mu\text{A})$

4.1.4 Display range

L.C.-----0.000 μA ~20.00 mA

I.R.-----0.01k Ω ~99.99G Ω

4.1.5 Test time

Parameter	Fast	Medium	Slow
L.C.	53mSec	70mSec	139mSec
I.R.	53mSec	70mSec	139mSec

※ Test condition is range hold, trigger mode is EXT, external trigger (EXTV DISP) displays OFF.

4.1.6 (NULL)

Clear out the leakage current in the whole return circuit.

4.2 (W.V. TEST)

4.2.1 Test parameter

Rising time T_r unit: Sec

Feather withstanding voltage V_t unit: V

4.2.2 Test signal

Charge current 0.5 mA ~ 80 mA; (TH2689)

0.5 mA ~ 130 mA; (TH2689A)

step 0.5mA

4.2.3 Display range

T_r ----- 110mSec~600Sec

Vt ----- 1.0V~V_{MAX}

V_{MAX} = 800V (TH2689)

= 500V (TH2689A)

Chapter 5 Remote Control

TH2689 has the RS232C serial interface and the parallel GPIB (optional) interface. Both interfaces can be used to remotely control TH2689, but they can not be used at the same time. The two interfaces share the same program commands, but they have different hardware configurations and different communication protocols. This chapter provides the information about the two interfaces and how to use the interfaces.

5.1 RS232C Interface Introduction

The RS232C interface can be used to remotely control the TH2689, and all operations from the front panel can be performed by a computer via the serial interface.

5.1.1 RS232C connection

RS232C Standard now is widely used as the serial communication standard. RS232 stands for Recommend Standard number 232 and C is the latest revision of the standard. The serial ports on most instruments use a subset of the RS-232C standard. The full RS-232C standard specifies a 25-pin "D" connector of which 22 pins are used. Most of these pins are not needed for normal serial communications, and the common RS232 signals are listed as follows.

Table 5-1 Definition of common RS232 serial interface pin

Function	Code	25 Pin Connector Pin Number	9 Pin Connector Pin Number
Request To Send	RTS	4	7
Clear To Send	CTS	5	8
Data Set Ready	DSR	6	6
Data Carrier Detect	DCD	8	1
Data Terminal Ready	DTR	20	4
Transmitted Data	TXD	3	3
Received Data	RXD	2	2
Signal Ground Common	GND	7	5

TH2689 only uses the smallest subset of the RS232C standard, the signal are listed as follows.

Function	Code	9 Pin Connector Pin Number
Transmitted Data	TXD	3
Received Data	RXD	2
Signal Ground Common	GND	5

Note: The definition of serial interface pin is basically the same as that of the connector of standard 9-core RS232C.

RS232C connector uses 9 core DB jacket, the order of pin is shown as the figure below:

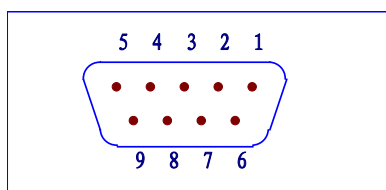

Warning: please turn off the power when connecting on or off the connector to avoid electrical shock;

5.1.2 Communication with a computer

- Diagram of connection to a controller:

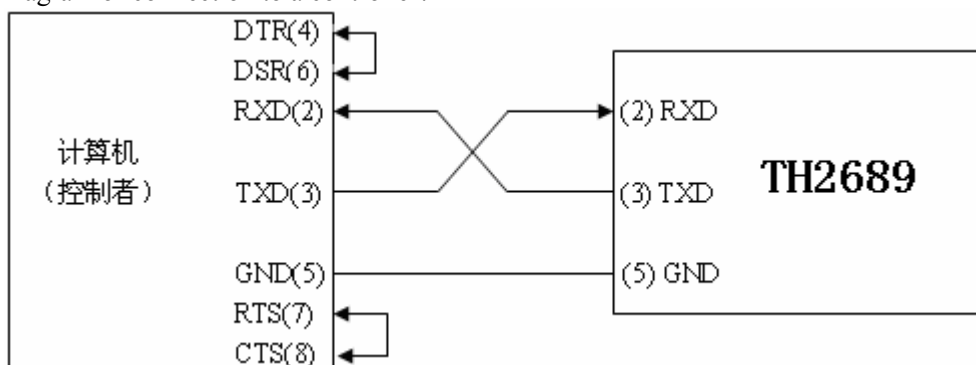

There may be the same between TH2689's RS232 interface and a standard RS232C interface. You can make the connection cable by yourself according the diagram or order one from our company.

Note: Pin 4 and 6, pin 7 and 8 are shorted respectively at the end of controller.

- Firstly, set the bus mode as RS232
- Main serial interface parameter

Serial Interface Specifications

Transmitted mode	Dual asynchronous communication including start and stop bit
Baud Rate	Pre-set 19200 bps
Data Bits	8 BIT
Stop Bits	1 BIT
Calibration	None
End of Sequence	NL (ASCII code 10)
Connection mode	Software
Connector	DB9

5.2 GPIB

5.2.1 GPIB Bus

IEEE488 (GPIB) general-used parallel bus interface is a general intelligent instrument bus interface standard. IEEE is the abbreviation of **Institute of Electrical and Electronics Engineers**, 488 is the standard number. Through this interface, the communication between computer and other

intelligent instruments can be collected, as well as an auto test system can be composed conveniently with other test instrument. In the same bus, many test instruments can be connected simultaneously. In this instrument, the IEEE488.2 standard is adopted, and the interface board can be selected and bought by user. The control instruction system is open, so user can use the computer operation interface, also can write a program based on this system to achieve the goal. The control instruction system supports most function that is to say; all function can be operated on controlling the computer to realize the remote control.

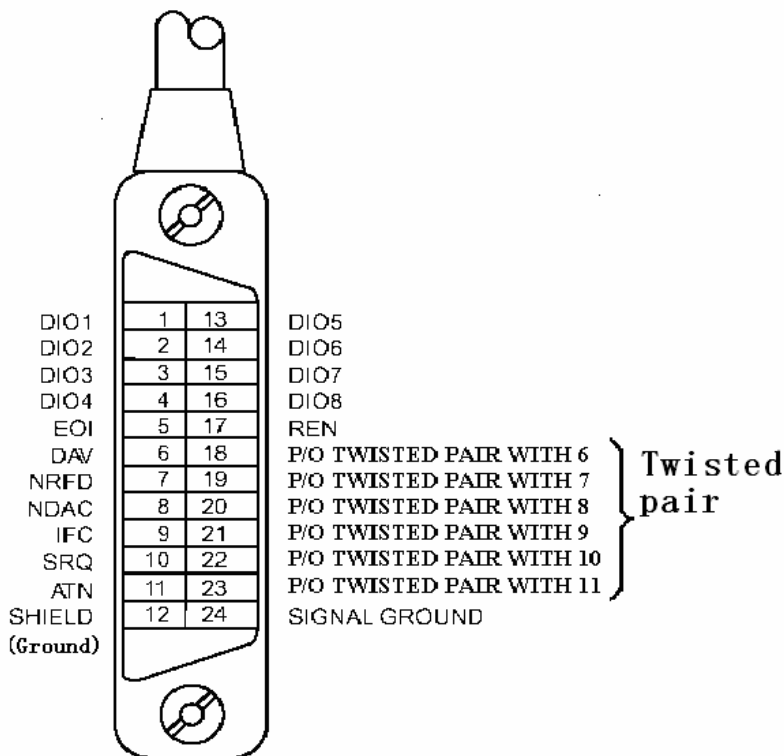

Figure 5-3 GPIB Structure Diagram of Connector Assembly/pin

When using GPIB system, the points below should be paid attention to:

- The total length of cable in one bus system must be less than or equal to two meters times the number of devices connected on the bus (the GPIB controller counts as one device) and the total length of cable must not exceed 20 meters.
- A maximum of 15 devices can be connected in one bus system.
- There are no restrictions on how the cables are connected together. However, it is recommended that no more than four piggyback connectors be stacked together on any one device.

GPIB cable connection mode-1

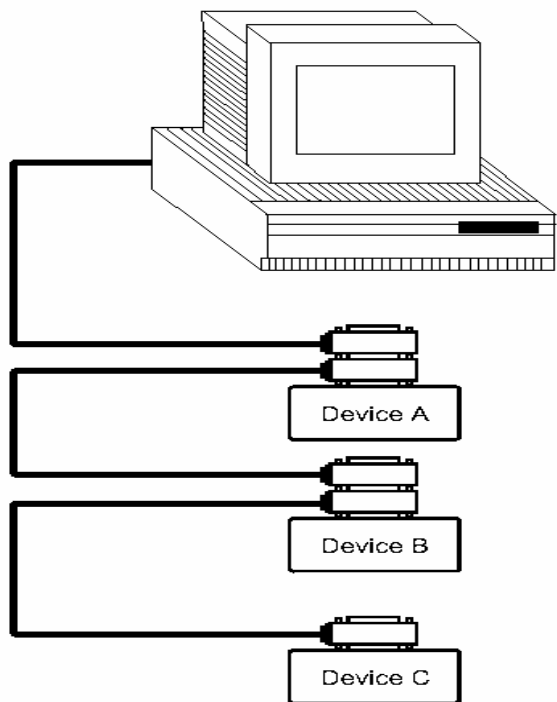

Figure 5-4 Double-piggyback Connector Superposition GPIB cable connection mode-2:

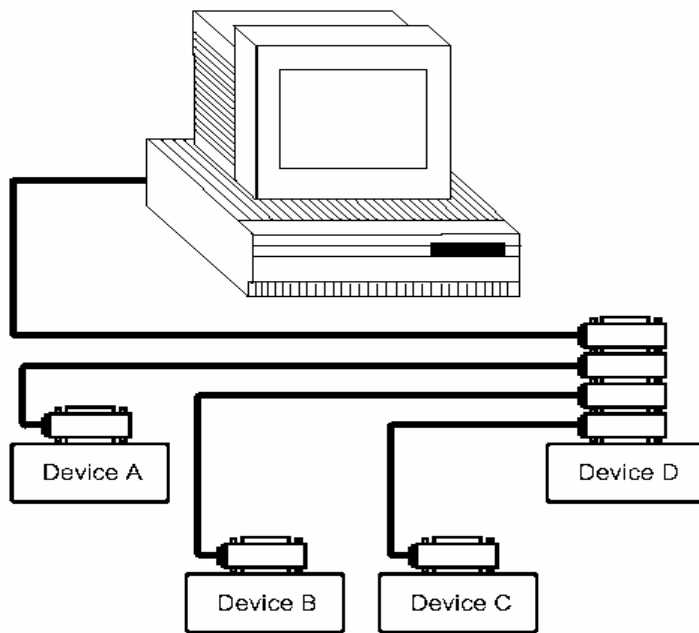

Figure 5-5 4-piggyback Connector Superposition

5.2.2 GPIB function

TH2689's GPIB functions are listed in the following table.

Code	Function
SH1	Complete Source Handshake capability
AH1	Complete Acceptor Handshake capability
T3	Basic Talker; Talk-Only; unaddressed if MLA; no serial poll
L3	Basic Listener; unaddressed if MTA; no Listen Only
RL1	Remote/Local capability
DC1	Device Clear capability
DT1	Device Trigger capability
C0	No Controller capability
E1	Drivers are open-collector

5.2.3 GPIB addressing

TH2825A's GPIB address is stored in non-volatile memory and can be set to any address from 0 to 30 by front panel key entry in the System Config page. When TH2825A is shipped from the factory, the default GPIB address is 8. For more information, refer to “§3.2.9GPIB Address”.

Chapter 6 Command reference

There are two types of command: GPIB sharing command and SCPI(standard command of programmable instrument) command. GPIB sharing command is defined by IEEE488.2-1987, these commands are available in all devices, but TH2689 doesn't support all sharing commands. SCPI command is a tree structure.

6.1 Sharing command instruction

1. *RST

Function: restart the instrument.

2. *IDN?

Function: query the information about 4 field (separated by comma).

Return value: company, model, version number

Example : TH2689 is "TongHui,2689, 800, Ver0.1 2008";
TH2689A is "TongHui,2689A, 500, Ver0.1 2008";

3. *TRG

Function: in the bus trigger mode,

4. *SAV

Function: Save file

Parameter: <numeric_value>

Instruction: <numeric_value> is the file ordinal number from 0~9

Example: *SAV 1

Attention: There is no clue when the existed file records are covered.

5. *RCL

Parameter: <numeric_value>

Function: Load the existed file records

Instruction: <numeric_value> is the file ordinal number from 0~9.

Example: *RCL 1

6.2 SCPI Order structure

Figure 6-1 SCPI command table

Command	Parameter	Return value
ABORt		[无查询]
CALCulate		
: LIMit		
: FORMat	{IR LC}	{IR LC}
: BEEPer		
: CONDition	{FAIL PASS}	{FAIL PASS}
: STATe	{OFF ON 0 1}	{0 1}
: CLEar		[no query]
: FAIL?	[only for query]	{0 (PASS) 1 (FAIL) }
: STATe	{OFF ON 0 1}	{0 1}
: UPPer		
[: DATA]	{ <numeric_value> MAX MIN }	<numeric_value> OFF
: LOWer		
[: DATA]	{ <numeric_value> MAX MIN }	<numeric_value> OFF
: ONOFF	{0 1 2 3}	{0 1 2 3}
: NULL		
[: IMMEDIATE]		[no query]
: DATA?	[only for query]	{NR3}, {NR3}, {NR3}, {NR3}, {NR3}
: STATe	{OFF ON 0 1}	{0 1}
DISPlay		
: STATe?	[only for query]	{LCTEST WVTEST NULL MAIN SYSTEM}
: LCTest		[no query]
: WVTest		[no query]
LCTest		
: SOURce		
: VOLTage	{ <numeric_value> MAX MIN }	<numeric_value>
: CURRent	{ <numeric_value> MAX MIN }	<numeric_value>
: CONFigure		
: FUNction	{SEQ STEP CONT}	{SEQ STEP CONT}
: SPEed	{FAST MEDium SLOW}	{FAST MEDIUM SLOW}
: RANGe	{<range> MAX MIN}	<range>
: AUTO	{OFF ON 0 1}	{0 1}
: CHGTime	{ <numeric_value> MAX MIN }	<numeric_value>
: DWELl	{ <numeric_value> MAX MIN }	<numeric_value>
: MEASure		
: STATe?	[only for query]	{CHG TEST DCHG}
: FETCh?	[only for query]	{0 (OK) 1 (ERROR) }, {NO PASS HIGH LOW }
: IR?	[only for query]	{NR3}
: LC?	[only for query]	{NR3}
: VMON?	[only for query]	{NR3}

Command	Parameter	Return value
---------	-----------	--------------

WVTest		
: SOURce		
: VOLTage	{ <numeric_value> MAX MIN }	<numeric_value>
: CURRent	{ <numeric_value> MAX MIN }	<numeric_value>
: CONFigure		
: TEND	{ <numeric_value> MAX MIN }	<numeric_value>
: CHGTEND	{ <numeric_value> MAX MIN }	<numeric_value>
: MEASure		
: STATe?	[only for query]	{CHG TEST DCHG}
: TRise?	[only for query]	{NR3}
: VTerminate?	[only for query]	{NR3}
: TEnd?	[only for query]	{NR3}
: VEnd?	[only for query]	{NR3}
[: DATA]		
: DATA?	[only for query]	<set1_N>, <set1_T>, <set1_V>; <set2_N>, <set2_T>, <set2_V>; <setn_N>, <setn_T>, <setn_V>;
: DATA: POINTs	<start>, <end>	<numeric_value>
TRIGger		
[: IMMEDIATE]		[noquery]
: SOURce	{INT MAN EXTERNAL BUS}	{INT MAN EXT BUS}
: DELay	{ <numeric_value> MAX MIN }	<numeric_value>
: EDGE	{FALLing RISing}	{FALL RISI}
SYSTEM		
: BEEPPer		
[: IMMEDIATE]		[no query]
: STATe	{OFF ON 0 1}	{0 1}
: LFRequency	{50 60}[HZ]	{50 60}[HZ]
: HANDler	{CLEAR HOLD}	{CLEAR HOLD}
: STATe	{OFF ON 0 1}	{0 1}
: CONTrast	<numeric_value>	<numeric_value>
: RANGEdwell	{ <numeric_value> MAX MIN }	<numeric_value>
: AVERage	{ <numeric_value> MAX MIN }	<numeric_value>
: PRESet		[no query]
: ERRor?	[only for query]	<numeric_value>, <string>

6.2.1 Order structure instruction

The top of tree structure order is root command, or called root. The specified path can help reach to the bottom order.

Command ending character: order input ending character, for example NL (line break, ASCIIcode is 10).

Colon (:): Colon is the command level, which means entering the next level of command.

Semicolon (;): semicolon means begin a mulNotele command.

interrogation (?): interrogation means query。

Comma (,): Comma is break of multi-parameter

Space (): Space is the break of command and parameter

Quote mark (‘ ’): Single quotes means the content quoted by original sample, and the command analyze program doesn't process on it

Asterisk (*): The command after asterisk is the sharing command.

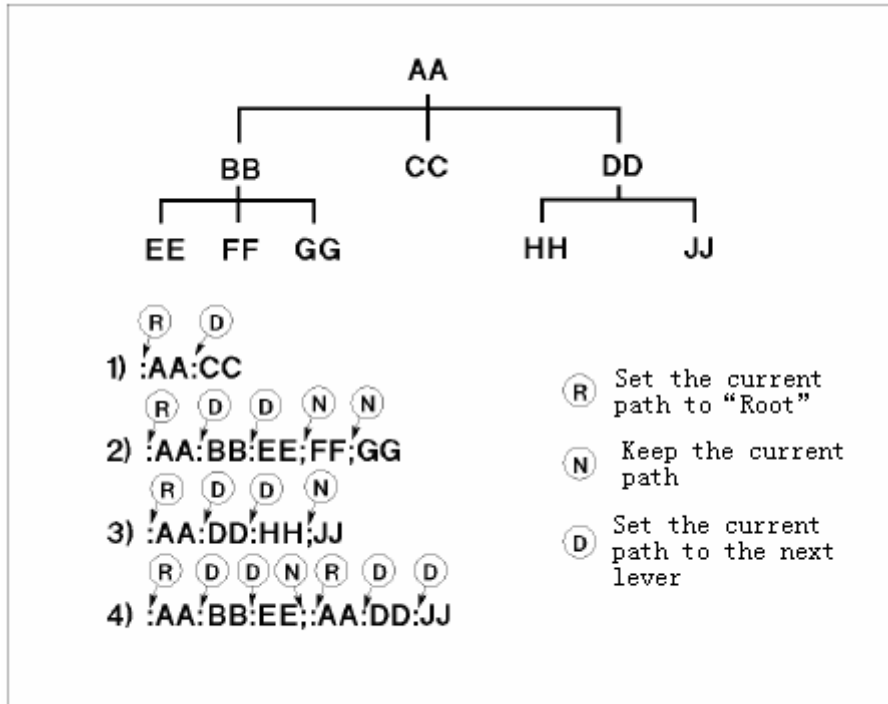

Figure 6-1 Correct Usage of Colon and Semicolon

According to the figure above, if send command

: AA: BB: EE; FF; GG

Which is equal to sending three commands as below?

: AA: BB: EE

: AA: BB: FF

: AA: BB: GG

6.3 Order syntax

- Sharing command syntax

There is no tree structure of SCPI command sharing command in sharing command, so no matter in which level, the command can be sent directly.

- The letters are not case sensitive

- Ending character

There are three kinds of ending character: [CARRIAGE RETURN] (0Dh) , [NEW LINE] (0Ah) and [CARRIAGE RETURN] (0Dh) +[NEW LINE] (0Ah) .

6.4 SCPI order instruction

6.4.1 ABORt order system

1. : ABORt

parameter: None

Return value: None

Function: Breakout the processing system instantly, and reset the trigger

6.4.2 CALCulate order system

1. : CALCulate: LIMit: FORMat {IR | LC}

Function: set or query the current test main parameter

Parameter: {IR | LC}

Return value: {IR | LC}

Instruction: IR the parameter is the resistance value
 LC the parameter is the current value

2. : CALCulate: LIMit: BEEPer: STATe { OFF | ON | 0 | 1}

Function: set or query the beeper

Parameter: { OFF | ON | 0 | 1}

Return value: { 0 | 1 }

instruction: OFF | 0 turn on beeper
 ON | 1 turn off beeper

3. : CALCulate: LIMit: BEEPer: CONDition {FAIL | PASS}

Function: set or query the compare output of beeper

Parameter: {FAIL | PASS}

Return value: {FAIL | PASS}

Instruction: FAIL Alarm when comparator result is FAIL
 PASS Alarm when comparator result is PASS

4. : CALCulate: LIMit: CLear

Function: Delete: CALCulate: LIMit: FAIL? command

Parameter: none

Return value: no

5. : CALCulate: LIMit: FAIL?

Function: send the comparator result

Parameter: none

Return value: { 0 | 1 }

Instruction: 0 comparator result is FAIL
 1 comparator result is PASS

6. : CALCulate: LIMit: STATe { OFF | ON | 0 | 1 }

Function: set or query if set up comparator function

Parameter: { OFF | ON | 0 | 1 }

Send-back vale: { 0 | 1 }

Instruction: OFF | 0 turn off comparator function
 ON | 1 turn on comparator function

7. : CALCulate: LIMit: UPPer[: DATA] {<numeric_value> | MIN | MAX}

Function: set or query the upper limit value of comparator function parameter, format is <NR3>

Parameter: {<numeric_value> | MIN | MAX}

Return value: numeric_value | OFF

Instruction: OFF

8. : CALCulate: LIMit: LOWer[: DATA] {<numeric_value> | MIN | MAX}

Function: set or query the low limit value of comparator function parameter, format is <NR3>

Parameter: {<numeric_value> | MIN | MAX}

Return value: numeric_value | OFF

Instruction: OFF

9. : CALCulate: LIMit: ONOff {0 | 1 | 2 | 3|4|5}

Function: set or query the selection of comparator function

Parameter: {0 | 1 | 2 | 3}

Return value: {0 | 1 | 2 | 3}

Instruction: 0 turn off comparator
 1 turn on comparator upper limit function
 2 turn on comparator low limit function
 3 turn on comparator upper and low limit function
 4 turn on comparator low limit function
 5 turn on comparator low limit function

10. : CALCulate: NULL[: IMMEDIATE]

Function: execute open correction of each bin (20mA, 2mA, 200uA, 20uA and 2uA)

Parameter: none

Return value: none

11. : CALCulate: NULL: DATA?

Function: query open correction value of each bin (20mA, 2mA, 200uA, 20uA and 2uA)

Parameter: none

Return value: numeric_value, numeric_value, numeric_value, numeric_value, numeric_value

12. : CALCulate: NULL: STATe { OFF | ON | 0 | 1 }

Function: set or query if set on open correction function

Parameter: { OFF | ON | 0 | 1 }

Return value: { 0 | 1 }

Instruction: OFF | 0 turn off open correction function
 ON | 1 turn on open correction function

6.4.3 DISPlay order system

1. : DISPlay: STATe?

Function: query the currently-displayed function page

Parameter: none

Return value: {LCTEST | WVTEST | NULL | MAIN | SYSTEM}

2. : DISPlay: LCTest

Function: switch function page as LC TEST

Parameter: none

Return value: none

3. : DISPlay: WVTest

Function: switch function page as WV TEST

Parameter: none

Return value: none

6.4.4 LCTest order system

1. : LCTest: SOURce: VOLTage {<numeric_value> | MIN | MAX}

Function: set or query the test voltage of LC/IR function

Parameter: {<numeric_value> | MIN | MAX}

Return value: numeric_value

Instruction: MIN	1V
MAX	800V (TH2689) 500V (TH2689A)

2. : LCTest: SOURce: CURRent {<numeric_value> | MIN | MAX}

Function: set or query the charge current of LC/IR function

Parameter: {<numeric_value> | MIN | MAX}

Return value: numeric_value

Instruction: MIN	0.5mA
MAX	500.0mA (LEV ≤ 100V) P _{MAX} / LEV (P _{MAX} =50W)

3. : LCTest: CONFigure: FUNCTion {SEQ | STEP | CONT}

Function: set or query the test mode of LC/IR function

Parameter: {SEQ | STEP | CONT}

Return value: {SEQ | STEP | CONT}

4. : LCTest: CONFigure: SPEed {FAST | MEDium | SLOW}

Function: set or query the test speed of LC/IR function

Parameter: {FAST | MEDium | SLOW}

Return value: {FAST | MEDium | SLOW}

5. : LCTest: CONFigure: RANGe {<numeric_value> | MIN | MAX}

Function: set or query range bin

Parameter: {<numeric_value> | MIN | MAX}

Return value: numeric_value

Instruction: numeric_value is 4 (20mA)、3 (2mA)、2 (200uA)、1 (20uA) 及 0 (2uA)
 MIN 为 2uA
 MAX 为 20mA

6. : LCTest: CONFigure: RANGE: AUTO { OFF | ON | 0 | 1 }

Function: set or query if set on auto switching bin mode

Parameter: {OFF | ON | 0 | 1}

Return value: { 0 | 1 }

Instruction: OFF | 0 select range bin manually
 ON | 1 select range bin automatically

7. : LCTest: CONFigure: CHGTime {<numeric_value> | MIN | MAX}

Function: set or query the charge time

Parameter: {<numeric_value> | MIN | MAX}

Return value: numeric_value

Instruction: numeric_value 为 0Sec~999Sec
 MIN is 0Sec
 MAX is 999Sec

8. : LCTest: CONFigure: DWELI {<numeric_value> | MIN | MAX}

Function: set or query the delay time value of SEQ test mode

Parameter: {<numeric_value> | MIN | MAX}

Return value: numeric_value

Instruction: numeric_value 为 0.2Sec~999.0Sec
 MIN is 0.2Sec
 MAX is 999.0Sec

9. : LCTest: MEASure: STATe?

Function: query the current test status

Parameter: none

Return value: {CHG | TEST | DCHG}

10. : LCTest: MEASure: FETCh?

Function: query test result

Parameter: none

Return value: {0 (OK) | 1 (ERROR) }, {NO | PASS | HIGH | LOW}

Instruction: 0 not in TEST status, or in TEST not over the range
 1 select a unsuitable range, can not obtain a correct test result
 NO not use comparator to make comparision
 PASS | HIGH | LOW comparator performs compare result

11. : LCTest: MEASure: IR?

Function: query IR value of test result

Parameter: none

Return value: numeric_value, format is <NR3>, unit is OHM

12. : LCTest: MEASure: LC?

Function: query LC value of test result

Parameter: none

Return value: numeric_value, format is <NR3>, unit is AMP

13. : LCTest: MEASure: VMON?

Function: query the voltage test value

Parameter: none

Return value: numeric_value, format is <NR3>, unit is VOLT

6.4.5 WVTest order system

1. : WVTest: SOURce: VOLTage {<numeric_value> | MIN | MAX}

Function: set or query the test voltage of WV function

Parameter: {<numeric_value> | MIN | MAX}

Return value: numeric_value

Instruction: MIN 1V
MAX 800V (TH2689)
500V (TH2689A)

2. : WVTest: SOURce: CURRent {<numeric_value> | MIN | MAX}

Function: set or query charge current of WV function

Parameter: {<numeric_value> | MIN | MAX}

Return value: numeric_value

Instruction: MIN 0.5mA
MAX P_{MAX} / V_{fMAX} ($P_{MAX}=65W$, V_{fMAX})

3. : WVTest: CONFigure: TEND {<numeric_value> | MIN | MAX}

Function: set or query the test ending time of WV function

Parameter: {<numeric_value> | MIN | MAX}

Return value: numeric_value

Instruction: MIN 0Sec
MAX 600Sec

4. : WVTest: CONFigure: CHGTEND {<numeric_value> | MIN | MAX}

Function: set or query the Max. charging time of WV function

Parameter: {<numeric_value> | MIN | MAX}

Return value: numeric_value

Instruction: MIN 5Sec
MAX 600Sec

5. : WVTest: MEASure: STATe?

Function: query the current test status

Parameter: none

Return value: {CHG | TEST | DCHG}

6. : WVTest: MEASure: TRise?

Function: query the rising time when test voltage reaches 0.9Vf (working voltage)

Parameter: none

Return value: numeric_value, format is <NR3>, unit is Sec

7. : WVTest: MEASure: VTerminate?

Function: query the test voltage value when test time reaches to Tend

Parameter: none

Return value: numeric_value, format is <NR3>, unit is V

8. : WVTest: MEASure: TEnd?

Function: query the total test time of WV: rising time (Tr) +test time

Parameter: none

Return value: numeric_value, format is <NR3>, unit is Sec

9. : WVTest: MEASure: VEnd?

Function: query the test voltage value when WV ends.

Parameter: none

Return value: numeric_value, format is <NR3>, unit is V

10. : WVTest: MEASure: DATA[: DATA]?

Function: return the data saved in buffer area, and the number of data is defined by POINTs command

Parameter: none

Return value: query the responded data is

<set1>: first group

<set2>: second group

..

<setn>: the last group

Each group includes parameter: <point>, <time>, <voltage>

Where

<point> is number, format is <NR1> ,

<time> is time data, format is <NR3>, unit is S

<voltage> is voltage data, format is <NR3>, unit is V

11. : WVTest: MEASure: DATA: POINTs <start>, <end>

Function: set or query the amount of data

Parameter: set the amount of returned data, where

<start>: set the start amount of returned data, set range as 1~220 (pre-set value is 1)

<end>: set the ending amount of returning data, set range as 1~220 (pre-set value is 220)

Return value: query the amount of data saved in buffer area. If return value is 0, which means no data saved, return value format is <NR1>

6.4.6 TRIGger order system**1. : TRIGger[: IMMEDIATE]**

Function: set on test function when the trigger mode is (BUS)

Parameter: none

Return value: none

2. : TRIGger: SOURce {INT | MAN | BUS | EXTernal}

Function: set or query trigger mode

Parameter: {INT | MAN | BUS | EXTernal}

Return value: {INT | MAN | BUS | EXTernal}

3. : TRIGger: DELay {<numeric_value> | MIN | MAX}

Function: set or query the delay time of external trigger source

Parameter: {<numeric_value> | MIN | MAX}

Return value: numeric_value

Instruction: MIN 0mSec

 MAX 9999mSec

4. : TRIGger: EDGE {FALL | RISE}

Function: set or query the external trigger signal mode

Parameter: {FALL | RISI}
 Return value: {FALL | RISI}
 Instruction: FALL fall trigger
 RISI rise trigger

6.4.7 SYSTEM order system

1. : SYSTEM: BEEPer[: IMMEDIATE]

Function: alarm once

Parameter: none

Return value: none

2. : SYSTEM: BEEPer: STATE {OFF | ON | 0 | 1}

Function: set or query if beeper has been set on

Parameter: {OFF | ON | 0 | 1}

Return value: { 0 | 1 }

Instruction: OFF | 0 turn off beeper
 ON | 1 turn on beeper

3. : SYSTEM: LFRequency {50 | 60}

Function: set or query the power frequency.

Parameter: {50 | 60 }

Return value: {50 | 60 |, unit is Hz

4. : SYSTEM: HANDler {CLEAR | HOLD}

Function: set or query the clear mode of HANDLER interface

Parameter: {CLEAR | HOLD}

Return value: {CLEAR | HOLD}

Instruction: CLEAR clear the last test result before testing
 HOLD the test result holds until the next test result changes

5. : SYSTEM: HANDler: STATE {OFF | ON | 0 | 1}

Function: set or query if set on HANDLER interface

Parameter: {OFF | ON | 0 | 1}

Return value: { 0 | 1 }

Instruction: OFF | 0 turn off HANDLER interface
 ON | 1 turn in HANDLER interface

6. : SYSTEM: CONTRast {<numeric_value>}

Function: set or query the contrast of LCD

Parameter: <numeric_value>

Return value: <numeric_value>, 0~31

7. : SYSTEM: RANGEDwell {<numeric_value> | MIN | MAX}

Function: set or query LC/IR range bin switch delay time

Parameter: {<numeric_value> | MIN | MAX}

Return value: numeric_value

Instruction: MIN 0.0Sec
 MAX 9.9Sec

8. : SYSTEM: AVErage {<numeric_value> | MIN | MAX }

Function: set or query average time

Parameter: {<numeric_value> | MIN | MAX}

Return value: numeric_value

Instruction: MIN 1
 MAX 8

9. : SYSTEM: PRESet

Function: reset to preset status

Parameter: none

Return value: none

10. : SYSTEM: ERRor?

Function: query the error information

Parameter: none

Return value: numeric_value string

Instruction: numeric_value error code
 string error string

6.5 Error information

Common error table:

Code	String
0	“No error”
-1	“Unknow message”
-2	“Syntax error”
-3	“Parameter error”
-4	“Data type error”
-5	“Data too long”
-6	“Invalid data”
-7	“Suffix error”
-8	“Can’t executed”
-9	“No record”
-10	“Too many errors“

Chapter 7 Sorting interface instruction

When using COMPARE, HANDLER is connected with external device and its connector is 24 core, the instruction of pin is as below.

7.1 HANDLER interface

Figure 7-1 HANDLER interface

Pin	Name
1	/EXT TRIG
2	/DISCHARGE
3, 20	/TEST
5-7	COM1
4, 24	X
8	GND
9	X
10	VEXT
11	VINT
12-14	X
15	/PASS
16	/CHARGE
17	/FAIL
18	/EOT
19	/HI
21	/LO
22	/ACQ
23	/FAIL_CHARGE

※Note: in figure 7-1,“/”means low level is valid.

7.2 The jumper set on HANDLER board

The jumper on HANDLER board is used to select internal or external power in outputting signal and controlling signal.

⚠warning:
Be sure the power jack has been removed
and operate after internal capacitor is discharged

☞**Note:** In figure 7-2 and 7-1, “N”means the default jumper setting.

Figure 7-2

Jumper		Description
No.	Position	
J901	Left	Use internal ground
	Right (N)	Use external ground
J902	Left	Use internal DC voltage source VCC(+5V), set J901 to left
	Right (N)	Use external DC voltage EXV1(5V-24V), set J901 to right

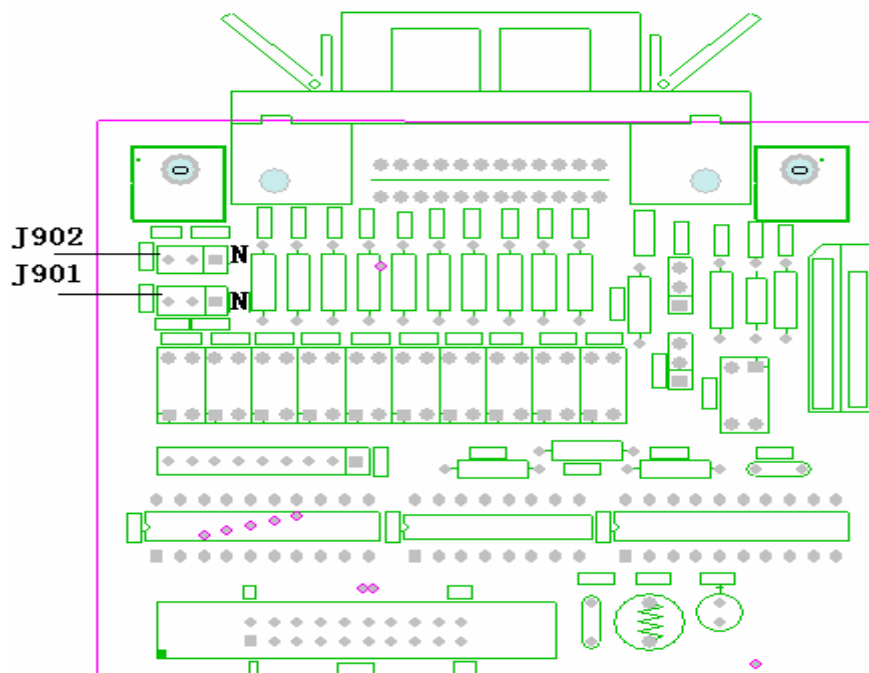

Figure 7-1

7.3 HANDLER interface signal diagram

(1) when in SEQ.TEST, HANDLER signal diagram

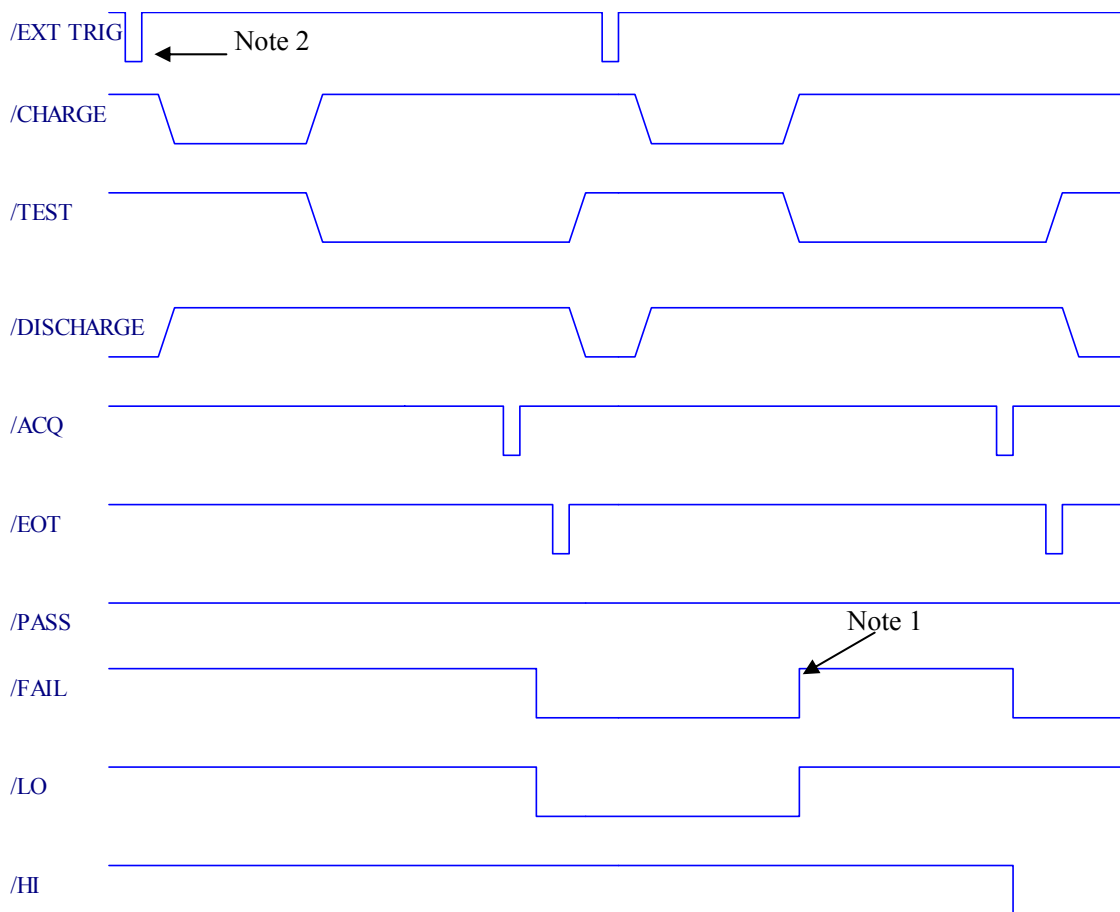

Figure 7-2 SEQ.TEST

※Note 1: HANDLER is in CLEAR mode, enter test status to clear out the last compare result of PASS/FAIL signal.

Note 2: confirm how long to enter charge status after receiving /EXT TRIG signal by setting TRIGDELAY.

(2) when in STEP TEST, HANDLER interface signal diagram

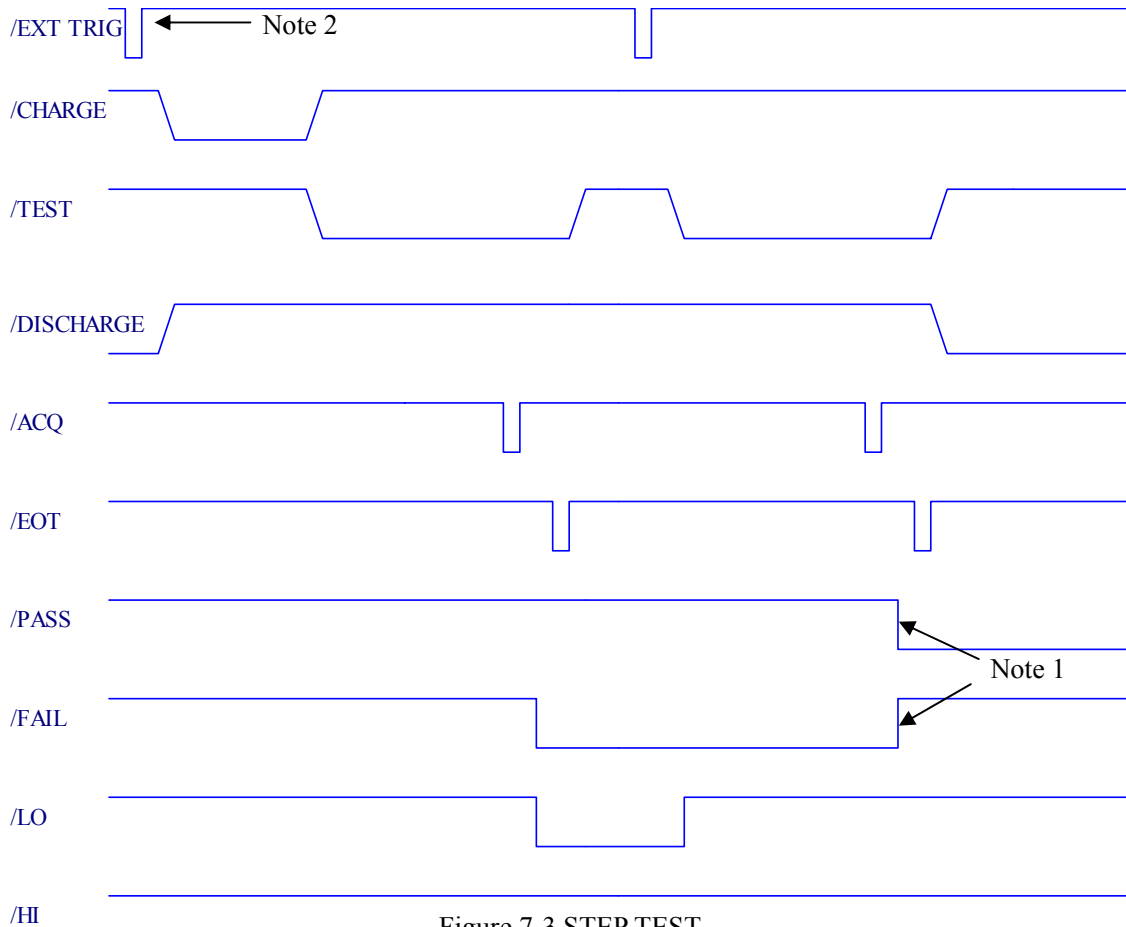

Figure 7-3 STEP TEST

※Note 1: When HANDLER is in HOLD mode, comparator result of PASS/FAIL signal is turned after the next result changes.

Note 2: when in discharge status, receive /EXT TRIG signal, the instrument charges automatically.

(3) Charge fail diagram

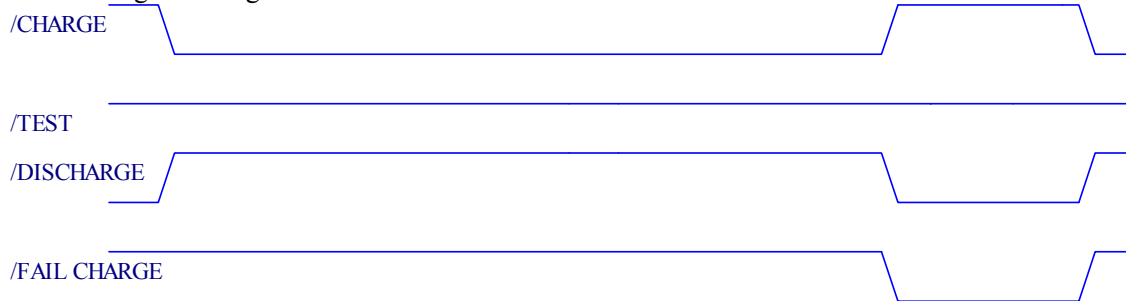

Figure 7-4

※Note : As for the /FAIL CHARGE signal generated by charge failing, clear out the signal in the next charge